

KEMA TYPE TEST CERTIFICATE OF COMPLETE TYPE TESTS

Object A direct connected, electronic three-phase four-wire energy meter **1186-19**

Type DTSY541 - active: class 1/B - reactive: class 2

Manufacturer Holley Technology Ltd.,
No.181 Wuchang Avenue, Yuhang District,
310023 HANGZHOU,
China

Production location Holley Technology Ltd.,
No.181 Wuchang Avenue, Yuhang District,
310023 HANGZHOU,
China

Tested by KEMA B.V.,
Arnhem, the Netherlands

Date of tests December 2018 to April 2019

The object, constructed in accordance with the description, drawings and photographs incorporated in this Certificate, has been subjected to the series of proving tests in accordance with the complete type test requirements of

**IEC 62052-11:2003, IEC 62053-21:2003, IEC 62053-23:2003,
EN 50470-1:2006, EN 50470-3:2006**

The results are shown in the record of proving tests. The values obtained and the general performance are considered to comply with the above standard(s) and to justify the ratings assigned by the manufacturer as listed in chapter 3.

This Certificate consists of 63 pages in total.

KEMA B.V.



Bas Verhoeven
Director, High-Voltage
Laboratory



Laboratories

Arnhem, 17 June 2019

INFORMATION SHEET

1 KEMA Type Test Certificate

A KEMA Type Test Certificate contains a record of a series of (type) tests carried out in accordance with a recognized standard. The object tested has fulfilled the requirements of this standard and the relevant ratings assigned by the manufacturer are endorsed by DNV GL. In addition, the object's technical drawings have been verified and the condition of the object after the tests is assessed and recorded. The Certificate contains the essential drawings and a description of the object tested. A KEMA Type Test Certificate signifies that the object meets all the requirements of the named subclauses of the standard. It can be identified by gold-embossed lettering on the cover and a gold seal on its front sheet.

The Certificate is applicable to the object tested only. DNV GL is responsible for the validity and the contents of the Certificate. The responsibility for conformity of any object having the same type references as the one tested rests with the manufacturer.

Detailed rules on types of certification are given in DNV GL's Certification procedure applicable to KEMA Laboratories.

2 KEMA Report of Performance

A KEMA Report of Performance is issued when an object has successfully completed and passed a subset (but not all) of test programs in accordance with a recognized standard. In addition, the object's technical drawings have been verified and the condition of the object after the tests is assessed and recorded. The report is applicable to the object tested only. A KEMA Report of Performance signifies that the object meets the requirements of the named subclauses of the standard. It can be identified by silver-embossed lettering on the cover and a silver seal on its front sheet.

The sentence on the front sheet of a KEMA Report of Performance will state that the tests have been carried out in accordance with The object has complied with the relevant requirements.

3 KEMA Test Report

A KEMA Test Report is issued in all other cases. Reasons for issuing a KEMA Test Report could be:

- Tests were performed according to the client's instructions.
- Tests were performed only partially according to the standard.
- No technical drawings were submitted for verification and/or no assessment of the condition of the object after the tests was performed.
- The object failed one or more of the performed tests.

The KEMA Test Report can be identified by the grey-embossed lettering on the cover and grey seal on its front sheet.

In case the number of tests, the test procedure and the test parameters are based on a recognized standard and related to the ratings assigned by the manufacturer, the following sentence will appear on the front sheet. The tests have been carried out in accordance with the client's instructions. Test procedure and test parameters were based on If the object does not pass the tests such behavior will be mentioned on the front sheet. Verification of the drawings (if submitted) and assessment of the condition after the tests is only done on client's request.

When the tests, test procedure and/or test parameters are not in accordance with a recognized standard, the front sheet will state the tests have been carried out in accordance with client's instructions.

4 Official and uncontrolled test documents

The official test documents of DNV GL are issued in bound form. Uncontrolled copies may be provided as a digital file for convenience of reproduction by the client. The copyright has to be respected at all times.

5 Accreditation of KEMA Laboratories

The KEMA Laboratories of DNV GL are accredited in accordance with ISO/IEC 17025 by the respective national accreditation bodies. KEMA Laboratories Arnhem, the Netherlands, is accredited by RvA under nos. L020, L218, K006 and K009. KEMA Laboratories Chalfont, United States, is accredited by A2LA under no. 0553.01. KEMA Laboratories Prague, the Czech Republic, is accredited by CAI as testing laboratory no. 1035. KEMA Laboratories Arnhem, the Netherlands, is also accredited by RvA in accordance with ISO/IEC 17020 under no. I049. KEMA Laboratories Arnhem, the Netherlands, is appointed as notified body with no. 2290 for 2014/32/EU Measuring Instruments Directive.

TABLE OF CONTENTS

1	Summary	6
2	Introduction	7
2.1	Applied Standards	8
2.2	Subcontractors	8
2.3	Measurement uncertainty	8
3	Data related to the energy meters tested and marking	9
3.1	Current specifications	10
3.2	Accuracy class for Wh	10
4	Results of the type test	11
4.1	Tests of the mechanical properties	11
4.1.1	General	11
4.1.2	Case	11
4.1.3	Spring Hammer test	11
4.1.4	Shock test	11
4.1.5	Vibration test	11
4.1.6	Protection against penetration of dust and water	12
4.1.7	Terminals and terminal block	12
4.1.8	Resistance to heat and fire	12
4.1.9	Register and output device	13
4.2	Tests of climatic influences	13
4.2.1	General	13
4.2.2	Dry heat test	13
4.2.3	Cold test	13
4.2.4	Damp heat cyclic test	14
4.2.5	Solar radiation test	14
4.3	Accuracy measurement at different loads	14
4.3.1	Interpretation of test results	14
4.3.2	Test of meter constant	15
4.3.3	Starting current	15
4.3.4	Test of no load condition	15
4.4	Effect of change of influence quantities on accuracy	15
4.4.1	Influence of ambient temperature variation	15
4.4.2	Effect of changes in the auxiliary supply voltage	17
4.4.3	Voltage variation	18
4.4.4	Frequency variation	18
4.4.5	Magnetic induction of external origin 0,5 mT	19
4.4.6	Harmonic components in the current and voltage circuits	19
4.4.7	DC and even harmonics in the a.c. current circuit	19

4.4.8	Odd harmonics in the a.c. current circuit	20
4.4.9	Sub-harmonics in the a.c. current circuit	20
4.4.10	Reversed phase sequence	20
4.4.11	Voltage unbalance	20
4.4.12	Continuous magnetic induction of external origin	21
4.4.13	Operation of accessories	21
4.4.14	Immunity to earth fault	21
4.5	Effect of short time over currents on the accuracy	21
4.6	Self-heating	22
4.6.1	Influence of self-heating on the accuracy	22
4.6.2	Heating	22
4.7	Power consumption of the voltage and current circuits	22
4.8	Fast transient burst test	23
4.8.1	Test method	23
4.8.2	Test levels	23
4.8.3	Test results	23
4.9	Electrostatic discharges	23
4.9.1	Test method	23
4.9.2	Test levels	23
4.9.3	Test results	23
4.10	Immunity to electromagnetic RF fields	24
4.10.1	Test method	24
4.10.2	Test levels	24
4.10.3	Test results	24
4.11	Immunity to conducted disturbances induced by RF fields	24
4.11.1	Test method	24
4.11.2	Test levels	24
4.11.3	Test results	25
4.12	Radio interference measurement	25
4.12.1	Test levels	25
4.12.2	Test results	25
4.13	Voltage dips and short interruptions	26
4.13.1	Test levels	26
4.13.2	Test results	26
4.14	Surge immunity test	26
4.14.1	Test method	26
4.14.2	Test levels	26
4.14.3	Test results	26
4.15	Damped oscillatory waves immunity test	27
4.16	Insulation	27
4.16.1	Impulse voltage test	27



KEMA Laboratories	- 5 -	1186-19
4.16.2	A.C. voltage test	27
4.17	Immunity to conducted disturbances 2-150 kHz	28
4.17.1	Test method	28
4.17.2	Test levels	28
4.17.3	Test results	28
5	Maximum permissible error	29
6	Durability and Reliability	31
7	Software and Protection against corruption.....	31
Appendix A	Accuracy test results.....	32
Appendix B	Photographs of the meter	40
Appendix C	Cross-reference table and checklist for static meters.....	51
Appendix D	Checklist for Measuring Instrument Directive MID 2014/32/EU.....	53
Appendix E	Measurement uncertainty	63

1 SUMMARY

The energy meter as described in chapter 3, meets the requirements of:

- | | | |
|-------------------|---|---|
| IEC 62052-11:2003 | : | Electricity metering equipment (a.c.) - General requirements, tests and test conditions - Metering equipment |
| IEC 62053-21:2003 | : | Electricity metering equipment (a.c.) - Static meters for active energy (classes 1 and 2) |
| IEC 62053-23:2003 | : | Electricity metering equipment (a.c.) - Static meters for reactive energy (classes 2 and 3) |
| EN 50470-1:2006 | : | Electricity metering equipment (a.c.)-part 1: General requirements, tests and test conditions - Metering equipment (class indexes A, B and C) |
| EN 50470-3:2006 | : | Electricity metering equipment (a.c.)-part 3: Particular requirements - Static meters for active energy (class indexes A, B and C) |

In addition, the meter meets the following requirements

- Immunity to conducted disturbances in the frequency range 2-150 kHz (EN 61000-4-19, 2014 and CLC/TR 50579, 2012). See paragraph 4.17.
- Water penetration test IPx4 instead of IPx1. See par 4.1.6
- Ambient temperature test against extended requirements (-40 °C to 80 °C) see paragraph 4.4.1.

Requirements for indoor use.

Based on a non-recurrent examination.

2 INTRODUCTION

The type test was carried out at KEMA Laboratories, from December 2018 to April 2019, on behalf of Holley Technology Ltd., on the meter as described in chapter 3.

The energy meters were tested in respect of the following requirements:

IEC 62052-11:2003	:	Electricity metering equipment (a.c.) - General requirements, tests and test conditions - Metering equipment
IEC 62053-21:2003	:	Electricity metering equipment (a.c.) - Static meters for active energy (classes 1 and 2)
IEC 62053-23:2003	:	Electricity metering equipment (a.c.) - Static meters for reactive energy (classes 2 and 3)
EN 50470-1:2006	:	Electricity metering equipment (a.c.)-part 1: General requirements, tests and test conditions - Metering equipment (class indexes A, B and C)
EN 50470-3:2006	:	Electricity metering equipment (a.c.)-part 3: Particular requirements - Static meters for active energy (class indexes A, B and C)

- Immunity to conducted disturbances in the frequency range 2-150 kHz (EN 61000-4-19, 2014 and CLC/TR 50579, 2012). See paragraph 4.17.
- Water penetration test IPx4 instead of IPx1. See par 4.1.6
- Ambient temperature test against extended requirements (-40 °C to 80 °C) see paragraph 4.4.1.

The energy meters use the same measuring elements for both Wh- and varh-measurement. The meter calculates both from the same voltage and current measurement (with respect to the angle between the voltage and current). In many tests verification of the Wh function is therefore sufficient to cover compliance to both Wh- and varh- standards.

For all types being part of this type test the test plan of each type is determined based on a comparison of the different types. The expected impact on the result of each test is based on of the differences and similarities between the types. Based on that impact it is decided which types need to be tested on which test.

The test plan was based on these assumptions.

All tests are performed at reference voltage and reference frequency, unless mentioned otherwise. The measurements are carried out with standards that are traceable to international standards.

2.1 Applied Standards

The product standard refers to documents, in whole or in part, these documents are normatively referenced to in this product standard and these documents are indispensable for its application. For dated references, only the edition cited applies. For undated references the latest edition of the referenced document (including any amendments) applies. KEMA Laboratories will use the latest edition of the referenced documents (including any amendments) in all cases, also in the cases reference is made to dated editions.

2.2 Subcontractors

The following tests were subcontracted to DEKRA Certification B.V., Arnhem, the Netherlands:

- Radiated radio interference measurement fields (30 to 1000 MHz) in accordance with IEC 62052-11 and CISPR 22.

The laboratory is accredited by RvA under accreditation number L022.

The following tests were subcontracted to Sebert Trillingstechniek BV, Bergschenhoek, the Netherlands:

- shock test in accordance with IEC 60068-2-27
- vibration test in accordance with IEC 60068-2-6.

The laboratory is accredited by RvA under accreditation number L540.

2.3 Measurement uncertainty

A table with measurement uncertainties is enclosed in this report. Unless otherwise stated, the measurement uncertainties of the results presented in this report are as indicated in that table.

3 DATA RELATED TO THE ENERGY METERS TESTED AND MARKING

Manufacturer	: Holley Technology Ltd.,
Contact person	: Daisy Sun
Address	: No.181 Wuchang Avenue, Yuhang District : 310023 HANGZHOU
Country	: China
Production site	: Holley Technology Ltd.,
Address	: No.181 Wuchang Avenue, Yuhang District : 310023 HANGZHOU
Country	: China
Instrument	: Electronic three-phase four-wire energy meter Direct connected
Mark - Type	: DTSY541
Register	: LCD
Accuracy Class	: Active: 1/B Reactive: 2
Measurement range	: 110/190 .. 240/415 V 0,25..5(100) A 50 Hz active: 1000 imp./kWh reactive: 1000 imp./kvarh
Temperature range	: -40 .. 80 °C
Use	: Indoor, not sensitive to phase sequence
Protection Class	: II
Environmental class	: M1, E1 and E2
Registry method	: Bi-directional method separate registers: received- and delivered energy of the whole connection is added in separate registers

Note

Production site information was copied from customer specification and not verified by KEMA Laboratories.

Sample identification:

99710284	DIN	DTSD545
99710285	DIN	DTSD545
99710286	DIN	DTSD545
99710288	DIN	DTSD545
99710289	DIN	DTSD545
99710276	BS	DTSY541
99710277	BS	DTSY541
99710278	BS	DTSY541
99710279	BS	DTSY541
99710283	BS	DTSY541
99710331	DIR (Pre-Pay, keypath), BS	DTSY541
99710332	DIR (Pre-Pay, keypath), BS	DTSY541
99710333	DIR (Pre-Pay, keypath), BS	DTSY541
99710336	DIR (Pre-Pay, keypath), BS	DTSY541
99710337	DIR (Pre-Pay, keypath), BS	DTSY541
99710338	DIR (Pre-Pay, keypath), BS	DTSY541
99710339	DIR (Pre-Pay, keypath), BS	DTSY541
99710340	DIR (Pre-Pay, keypath), BS	DTSY541
99710343	DIR (Pre-Pay, keypath), BS	DTSY541

Photographs of the approved meter: See appendix B.

The meter contains all required markings.

The tests were carried out in conformity with IEC 62052-11, IEC 62053-21, IEC 62053-23, EN 50470-1 and EN 50470-3 using a static energy standard. The measurements are carried out with standards that are traceable to international standards. The results in this report relate only to the items tested.

3.1 Current specifications

The current values in this document are all based on the reference current. The relationships between the different terms of the current are clarified in the following table.

Current 0,25 .. 5(100)			
Current specification		Current A	Percentage of the reference current I_{ref}
Starting current	I_{st}	0,02	$\leq 0,4\%$
Minimum current	I_{min}	0,25	$\leq 5\%$
Transitional current	I_{tr}	0,5	10%
Basic current	I_b	5	100%
Maximum current	I_{max}	100	$\geq 500\%$

3.2 Accuracy class for Wh

The definition of the accuracy class indication of the meter is slightly different for the two standards mentioned in this document. Class B is comparable, but not identical to Class 1. This document covers all the requirements needed for the type test of a kWh meter according to Class 1 (IEC 62052-11) and Class B (EN 50470-1).

4 RESULTS OF THE TYPE TEST

4.1 Tests of the mechanical properties

4.1.1 General

The meter was subjected to the mechanical tests. In order to evaluate the materials used and the construction of the meter, the meters were assessed with regard to the following points.

4.1.2 Case

The meter can be sealed in such a way that the inside of the meter is only accessible after breaking the seal. See photograph appendix B.

4.1.3 Spring Hammer test

After carrying out the spring hammer test according to EN-IEC 60068-2-75 with a kinetic energy of 0,2 J, it showed that the mechanical strength of the meter case of the energy meter is adequate.

4.1.4 Shock test

This test was carried out on meter no. 99710278.

A shock test was performed according to EN-IEC 60068-2-27, with a half-sine pulse, a peak acceleration of 300 m/s² and a pulse duration of 18 ms. After this test the meter showed no damage.

4.1.5 Vibration test

This test was carried out on meter no. 99710337.

A vibration test according to EN-IEC 60068-2-6, test procedure A, was carried out on the meters in non-operating condition, frequency range from 10 Hz to 150 Hz, with a constant movement amplitude of 0,075 mm up to 60 Hz and a constant acceleration of 9,8 m/s² above 60 Hz. Per axis 10 sweep cycles were carried out. After the test the meter showed no damage.

4.1.6 Protection against penetration of dust and water

This test was carried out on meter no. 99710283, 99710339 (dust) 99710340 and 99710289 (Water).

The test was carried out according to EN-IEC 60529, protection degree IP54 (indoor).

The meter is dustproof as required by EN 50470-1 and IEC 62052-11 (Cat. 2 according to EN-IEC 60529).

The results of the water penetration test were satisfying.

The meter meets the requirements.

4.1.7 Terminals and terminal block

The clearances and creepage distances in the terminal block are adequate.

The terminal block material was tested in accordance with ISO 75 at a temperature of 135 °C and a pressure of 1,8 MPa (method A). The worst case deflection at 135 °C was 0,00 mm (requirement $\leq 0,34$ mm). The material meets the requirements.

Specification of the material:

Type: PC+20%GF

Manufacturer: CGN

Colour: GE COLOR CHIP NO.GD4023

The terminal cover can be sealed independently of the meter cover.

4.1.8 Resistance to heat and fire

The material of both the terminal block and the meter case was subjected to a glow-wire test in accordance with EN-IEC 60695-2-10 and EN-IEC 60695-2-11. The temperature of the glow-wire was 960 °C for the terminal block, 650 °C for the meter case and cover. The materials meet the requirements.

4.1.9 Register and output device

The meter has an LCD and records in kWhs and kvarhs.

On the front of the meter optical (LED) outputs are available for Wh- and varh measurements.

The energy registry method with regards to delivered- and received energy is the Bi-directional method with separate registers: received- and delivered energy of the whole connection is added in separate registers

The meter meets the requirements.

4.2 Tests of climatic influences

4.2.1 General

In order to evaluate the materials used and the construction of the meter, the relevant meter was assessed with regard to the following points.

4.2.2 Dry heat test

This test was carried out on meter no. 99710337.

The test was carried out according to EN-IEC 60068-2-2, at a temperature of 70 °C for a duration of 72 hours.

Afterwards, the meter showed no damage or loss of information.

4.2.3 Cold test

This test was carried out on meter no. 99710337.

The test was carried out according to EN-IEC 60068-2-1, at a temperature of -25 °C for a duration of 72 hours.

Afterwards the meter showed no damage or loss of information.

4.2.4 Damp heat cyclic test

This test was carried out on meter no. 99710337.

The test was carried out according to EN-IEC 60068-2-30 (variant 1) with an upper temperature of 40 °C for 6 cycles.

An insulation test was carried out. The meter showed no damage or loss of information.

The meter meets the requirements.

4.2.5 Solar radiation test

This test is not applicable to indoor meters.

4.3 Accuracy measurement at different loads

These tests were carried out on meter no. 99710285 and 99710338.

The meters were examined at an ambient temperature of (23 ± 2) °C and after the voltage circuits had been connected to reference voltage for at least 1 hour.

The measuring conditions were as specified in section 8.7.1 of EN 50470-3 and in section 8.5 of IEC 62053-21. The measurements were made with an accurate static energy standard.

The percentage error of the meter can be expressed as follows:

$$p = \frac{PM - PA}{PA} \times 100\%$$

in which

p	=	percentage error
PM	=	energy recorded by meter
PA	=	actual energy.

The values for the errors registered at different currents and various values for $\cos \varphi$ / $\sin \varphi$, at reference voltage and reference frequency (average of 3 repeatable measurements per load point), can be found in appendix A. The results show that the static energy meters, under the reference conditions given in section 8.7.1. of EN 50470-3 and in section 8.5 of IEC 62053-21, meet the requirements given in the relevant publication.

4.3.1 Interpretation of test results

There was no need to displace the zero line to bring the errors of the kWh-meters within the limits.

4.3.2 Test of meter constant

A test has been carried out to prove that the relation between the test output and the registered energy (display) is correct.

4.3.3 Starting current

The minimum load at which the energy meters tested recorded Whs at reference voltage, reference frequency and $\cos \varphi = 1$ was less than 0,3 % of I_{ref} (req. $\leq 0,4 \% I_{ref}$).

The minimum load at which the energy meters tested recorded varhs at reference voltage, reference frequency and $\sin \varphi = 1$ was less than 0,3 % of I_{ref} (req. $\leq 0,4 \% I_{ref}$).

4.3.4 Test of no load condition

At zero current, reference frequency and a voltage of 115% U_n , no pulse was generated by the energy meters tested.

The meter meets the requirements.

4.4 Effect of change of influence quantities on accuracy

4.4.1 Influence of ambient temperature variation

The meter was placed into a climatic room with ambient temperatures as shown in the table below until thermal equilibrium was reached. The measured deviations in the errors according to IEC 62053-21 are shown in the following table.

Serial number 99710338		Wh-measurement							
I in % of I_b	$\cos \varphi$	Temperature coefficient for the specified temperature range in % per K							
		-40..-25	-25..-10	-10..5	5..23	23..40	40..55	55..70	70..80
5	1	0,001%	0,002%	0,002%	0,003%	0,003%	0,003%	0,003%	0,002%
10	0,5 ind.	0,003%	0,001%	0,002%	0,004%	0,004%	0,005%	0,004%	0,004%
100	1	0,001%	0,002%	0,002%	0,003%	0,004%	0,003%	0,002%	0,001%
100	0,5 ind.	0,002%	0,002%	0,003%	0,003%	0,004%	0,003%	0,003%	0,003%
I_{max}	1	0,001%	0,001%	0,003%	0,003%	0,003%	0,003%	0,002%	0,001%
I_{max}	0,5 ind.	0,002%	0,002%	0,003%	0,004%	0,005%	0,006%	0,009%	0,013%

Serial number 99710285		Wh-measurement							
I in % of I_b	$\cos \varphi$	Temperature coefficient for the specified temperature range in % per K							
		-40..-25	-25..-10	-10..5	5..23	23..40	40..55	55..70	70..80
5	1	0,003%	0,003%	0,002%	0,004%	0,004%	0,005%	0,002%	0,002%
10	0,5 ind.	0,003%	0,003%	0,003%	0,004%	0,005%	0,006%	0,003%	0,005%
100	1	0,002%	0,003%	0,003%	0,003%	0,004%	0,003%	0,003%	0,003%
100	0,5 ind.	0,003%	0,003%	0,003%	0,004%	0,004%	0,003%	0,004%	0,004%
I_{max}	1	0,003%	0,003%	0,003%	0,004%	0,003%	0,003%	0,003%	0,003%
I_{max}	0,5 ind.	0,003%	0,003%	0,003%	0,005%	0,004%	0,005%	0,006%	0,008%

Serial number 99710338		varh-measurement							
I in % of I _b	sin φ	Temperature coefficient for the specified temperature range in % per K							
		-40..-25	-25..-10	-10..10	10..30	30..45	45..55	55..70	70..80
10	1	0,002%	0,001%	0,002%	0,004%	0,003%	0,003%	0,003%	0,003%
20	0,5 ind.	0,001%	0,002%	0,002%	0,003%	0,003%	0,001%	0,001%	0,000%
100	1	0,001%	0,002%	0,002%	0,004%	0,003%	0,003%	0,002%	0,003%
100	0,5 ind.	0,001%	0,001%	0,002%	0,003%	0,003%	0,002%	0,000%	0,002%
I _{max}	1	0,001%	0,002%	0,003%	0,003%	0,003%	0,003%	0,002%	0,003%
I _{max}	0,5 ind.	0,001%	0,001%	0,002%	0,002%	0,001%	0,002%	0,005%	0,008%

Serial number 99710285		varh-measurement							
I in % of I _b	sin φ	Temperature coefficient for the specified temperature range in % per K							
		-40..-25	-25..-10	-10..10	10..30	30..45	45..55	55..70	70..80
10	1	0,002%	0,003%	0,003%	0,004%	0,004%	0,002%	0,001%	0,002%
20	0,5 ind.	0,003%	0,002%	0,004%	0,003%	0,003%	0,001%	0,001%	0,001%
100	1	0,002%	0,003%	0,004%	0,003%	0,004%	0,003%	0,003%	0,003%
100	0,5 ind.	0,003%	0,003%	0,005%	0,002%	0,003%	0,003%	0,003%	0,001%
I _{max}	1	0,003%	0,003%	0,003%	0,004%	0,004%	0,004%	0,003%	0,003%
I _{max}	0,5 ind.	0,002%	0,002%	0,003%	0,003%	0,003%	0,001%	0,001%	0,002%

The meter meets the requirements.

The measured values of the additional percentage errors according to EN 50470-3 are shown in the following table.

Serial number 99710338			Wh-measurement								
I in % of I _{ref}	cos φ	Phase	Additional percentage error due to temperature variation %								
			-40 °C	-25 °C	-10 °C	5 °C	30 °C	40 °C	55 °C	70 °C	80 °C
5	1	RST	-0,12%	-0,11%	-0,08%	-0,05%	0,03%	0,05%	0,09%	0,13%	0,15%
10	1	RST	-0,13%	-0,10%	-0,08%	-0,06%	0,02%	0,06%	0,10%	0,13%	0,15%
10	0,5 ind.	RST	-0,16%	-0,12%	-0,10%	-0,07%	0,03%	0,07%	0,14%	0,20%	0,24%
10	0,8 cap.	RST	-0,11%	-0,09%	-0,07%	-0,04%	0,02%	0,06%	0,09%	0,12%	0,11%
10	1	R	-0,21%	-0,18%	-0,13%	-0,08%	0,03%	0,07%	0,13%	0,19%	0,22%
10	0,5 ind.	R	-0,27%	-0,20%	-0,15%	-0,10%	0,03%	0,07%	0,15%	0,22%	0,27%
10	1	S	-0,07%	-0,07%	-0,05%	-0,03%	0,03%	0,07%	0,09%	0,09%	0,10%
10	0,5 ind.	S	-0,14%	-0,10%	-0,08%	-0,05%	0,04%	0,09%	0,13%	0,14%	0,16%
10	1	T	-0,07%	-0,07%	-0,05%	-0,03%	0,03%	0,06%	0,10%	0,13%	0,16%
10	0,5 ind.	T	-0,10%	-0,08%	-0,07%	-0,05%	0,04%	0,07%	0,14%	0,21%	0,25%
I _{max}	1	RST	-0,13%	-0,11%	-0,09%	-0,05%	0,03%	0,05%	0,09%	0,12%	0,14%
I _{max}	0,5 ind.	RST	-0,18%	-0,15%	-0,12%	-0,07%	0,04%	0,09%	0,18%	0,31%	0,20%
I _{max}	0,8 cap.	RST	-0,11%	-0,09%	-0,07%	-0,04%	0,02%	0,04%	0,05%	0,03%	0,13%
I _{max}	1	R	-0,25%	-0,20%	-0,15%	-0,09%	0,02%	0,06%	0,11%	0,15%	0,44%
I _{max}	0,5 ind.	R	-0,29%	-0,23%	-0,17%	-0,11%	0,04%	0,10%	0,17%	0,27%	-0,01%
I _{max}	1	S	-0,09%	-0,08%	-0,06%	-0,04%	0,02%	0,04%	0,05%	0,06%	0,18%
I _{max}	0,5 ind.	S	-0,17%	-0,16%	-0,13%	-0,08%	0,05%	0,13%	0,29%	0,56%	0,39%
I _{max}	1	T	-0,08%	-0,07%	-0,06%	-0,05%	0,03%	0,07%	0,09%	0,12%	0,06%
I _{max}	0,5 ind.	T	-0,12%	-0,11%	-0,09%	-0,07%	0,04%	0,09%	0,16%	0,28%	0,80%

Serial number 99710285			Wh-measurement								
I in % of I _{ref}	cos φ	Phase	Additional percentage error due to temperature variation %								
			-40 °C	-25 °C	-10 °C	5 °C	30 °C	40 °C	55 °C	70 °C	80 °C
5	1	RST	-0,19%	-0,15%	-0,10%	-0,07%	0,01%	0,07%	0,14%	0,17%	0,19%
10	1	RST	-0,18%	-0,15%	-0,09%	-0,07%	0,02%	0,07%	0,13%	0,17%	0,19%
10	0,5 ind.	RST	-0,19%	-0,15%	-0,11%	-0,07%	0,05%	0,09%	0,18%	0,22%	0,27%
10	0,8 cap.	RST	-0,18%	-0,15%	-0,10%	-0,07%	0,01%	0,05%	0,12%	0,15%	0,17%
10	1	R	-0,18%	-0,15%	-0,10%	-0,06%	0,02%	0,07%	0,13%	0,16%	0,19%
10	0,5 ind.	R	-0,23%	-0,18%	-0,15%	-0,10%	0,02%	0,07%	0,13%	0,18%	0,20%
10	1	S	-0,20%	-0,16%	-0,11%	-0,07%	0,02%	0,07%	0,13%	0,17%	0,19%
10	0,5 ind.	S	-0,22%	-0,18%	-0,14%	-0,09%	0,01%	0,08%	0,18%	0,23%	0,28%
10	1	T	-0,16%	-0,13%	-0,10%	-0,07%	0,03%	0,07%	0,13%	0,18%	0,20%
10	0,5 ind.	T	-0,19%	-0,16%	-0,10%	-0,07%	0,03%	0,09%	0,18%	0,22%	0,25%
I _{max}	1	RST	-0,19%	-0,15%	-0,11%	-0,07%	0,01%	0,05%	0,10%	0,15%	0,19%
I _{max}	0,5 ind.	RST	-0,22%	-0,18%	-0,14%	-0,09%	0,02%	0,07%	0,14%	0,23%	0,22%
I _{max}	0,8 cap.	RST	-0,15%	-0,12%	-0,08%	-0,04%	0,03%	0,06%	0,10%	0,12%	0,18%
I _{max}	1	R	-0,18%	-0,15%	-0,11%	-0,06%	0,03%	0,05%	0,10%	0,14%	0,31%
I _{max}	0,5 ind.	R	-0,20%	-0,17%	-0,12%	-0,07%	0,03%	0,08%	0,16%	0,27%	0,12%
I _{max}	1	S	-0,20%	-0,16%	-0,12%	-0,07%	0,02%	0,05%	0,10%	0,14%	0,17%
I _{max}	0,5 ind.	S	-0,23%	-0,19%	-0,14%	-0,08%	0,04%	0,08%	0,18%	0,29%	0,41%
I _{max}	1	T	-0,16%	-0,13%	-0,10%	-0,06%	0,03%	0,06%	0,11%	0,17%	0,17%
I _{max}	0,5 ind.	T	-0,20%	-0,17%	-0,13%	-0,08%	0,03%	0,08%	0,16%	0,23%	0,43%

The meter meets the requirements.

4.4.2 Effect of changes in the auxiliary supply voltage

Not applicable.

4.4.3 Voltage variation

This test was carried out on meter no. 99710285 and 99710338.

The change in the error due to a 10% change of the measuring voltage over the complete voltage range of the meter was measured at various loads.

The maximum change in error was:

Balanced load:

- 0,02% registering Wh at $\cos \varphi = 1$ (Requirement $\leq 0,7\%$)
- 0,02% registering Wh at $\cos \varphi = 0,5$ ind. (Requirement $\leq 1,0\%$)
- 0,02% registering Wh at $\cos \varphi = 0,8$ cap. (Requirement $\leq 1,0\%$)
- 0,02% registering varh at $\sin \varphi = 1$ (Requirement $\leq 1,0\%$)
- 0,02% registering varh at $\sin \varphi = 0,5$ ind. (Requirement $\leq 1,5\%$).

Single phase load:

- 0,06% registering Wh at $\cos \varphi = 1$ (Requirement $\leq 1,0\%$)
- 0,07% registering Wh at $\cos \varphi = 0,5$ ind. (Requirement $\leq 1,5\%$).

Severe voltage variations were tested in accordance with EN 50470-3 and IEC 62053-21.

The meter meets the requirements.

4.4.4 Frequency variation

This test was carried out on meter no. 99710285 and 99710338.

The change in the error due to a 2% change of the reference frequency over the complete voltage range of the meter was measured at various loads.

The maximum change in error was:

Balanced load:

- 0,02% registering Wh at $\cos \varphi = 1$ (Requirement $\leq 0,5\%$)
- 0,02% registering Wh at $\cos \varphi = 0,5$ ind. (Requirement $\leq 0,7\%$)
- 0,01% registering Wh at $\cos \varphi = 0,8$ cap. (Requirement $\leq 0,7\%$)
- 0,01% registering varh at $\sin \varphi = 1$ (Requirement $\leq 2,5\%$)
- 0,02% registering varh at $\sin \varphi = 0,5$ ind. (Requirement $\leq 2,5\%$).

Single phase load:

- 0,01% registering Wh at $\cos \varphi = 1$ (Requirement $\leq 0,7\%$)
- 0,02% registering Wh at $\cos \varphi = 0,5$ ind. (Requirement $\leq 1,0\%$).

The meter meets the requirements.

4.4.5 Magnetic induction of external origin 0,5 mT

This test was carried out on meter no. 99710288 and 99710332.

An external magnetic field was generated using a round coil measuring 1 meter in diameter. The field was applied in all three directions in order to determine the worst-case position. The phase position of the field current (with respect to the measuring voltage) was shifted between 0° and 360°.

The maximum change measured at reference voltage, reference current and reference frequency was 0,02%. The maximum permissible change allowed by EN 50470-3 and IEC 62053-21 is 2,0%.

The maximum permissible change allowed by IEC 62053-23 is 3,0%.

The meter meets the requirements.

4.4.6 Harmonic components in the current and voltage circuits

This test was carried out on meter no. 99710285 and 99710338.

Using the special amplifiers of the meter test equipment, 10% of fifth harmonic was added to the voltage and 40% of fifth harmonic was added to the current. Using a load at $0,5 I_{max}$, a 4% increase of power in the fifth harmonic in relation to the nominal frequency was generated. The energy measured was compared to the energy measured by the standard equipment.

The worst case change in the error was 0,02%.

The maximum permissible change allowed by EN 50470-3 and IEC 62053-21 is 0,8%.

The meter meets the requirements.

4.4.7 DC and even harmonics in the a.c. current circuit

This test was carried out on meter no. 99710284 and 99710288.

Using diodes, a rectified waveform was generated in the meter current circuits according to Annex C1 of EN 50470-3 and Annex A1 of IEC 62053-21. The energy measured was compared to the energy measured by the standard equipment. The test was carried out at a current of $I_{max}/\sqrt{2}$. The worst case change in the error was 0,61%. The maximum permissible change allowed by EN 50470-3 and IEC 62053-21 is 3,0%.

The meter meets the requirements.

4.4.8 Odd harmonics in the a.c. current circuit

This test was carried out on meter no. 99710285 and 99710338.

Using the special amplifiers of the meter test equipment, a phase-fired waveform was generated in the current circuits according to Annex C2 of EN 50470-3 and Annex A2 of IEC 62053-21. The energy measured was compared to the energy measured by an energy standard. The worst case difference was 0,01%.

The maximum permissible change allowed by EN 50470-3 and IEC 62053-21 is 3,0%.

The meter meets the requirements.

4.4.9 Sub-harmonics in the a.c. current circuit

This test was carried out on meter no. 99710285 and 99710338.

Using the special amplifiers of the meter test equipment, a "2 on 2 off cycle burst" was generated in the current circuits according to Annex C3 of EN 50470-3 and Annex A3 of IEC 62053-21. The energy measured was compared to the energy measured by an energy standard. The worst case difference was 0,01%.

The maximum permissible change allowed by EN 50470-3 and IEC 62053-21 is 3,0%.

The meter meets the requirements.

4.4.10 Reversed phase sequence

This test was carried out on meter no. 99710285 and 99710338.

The change in the error with reversed phase sequence was compared with the error with normal phase sequence measured at reference voltage, rated frequency and 10% of the reference current at $\cos\phi = 1$. The worst case change in error was 0,04%.

The maximum permissible change allowed by EN 50470-3 and IEC 62053-21 is 1,5%.

The meter meets the requirements.

4.4.11 Voltage unbalance

This test was carried out on meter no. 99710285 and 99710338.

The influence of an interruption of one phase of the three-phase network, at reference voltage, rated frequency and reference current, on the accuracy of the meter was 0,03%.

The influence of an interruption of two phases was 0,03%.

The maximum permissible change allowed by EN 50470-3 and IEC 62053-21 is 2,0%.

The meter meets the requirements.

4.4.12 Continuous magnetic induction of external origin

This test was carried out on meter no. 99710286 and 99710288.

The magnetic field was generated using an electromagnet as described in annex E of EN 50470-1 and Annex B of IEC 62053-21. The change in the error due to this magnetic field was less than 0,01% (requirement $\leq 2,0\%$).

The meter meets the requirements.

4.4.13 Operation of accessories

Operation of accessories did not influence the registration of the meter.

4.4.14 Immunity to earth fault

Not applicable.

4.5 Effect of short time over currents on the accuracy

This test was carried out on meter no. 99710339.

A current of 30 times I_{\max} flowed through the current circuit of the energy meter for a period of one half-cycle (10 ms), with the voltage circuits being supplied with nominal voltage.

Both before and after the test the error was measured at reference current, reference voltage, rated frequency and $\cos \varphi = 1$. The difference in the error measured before and after this test is listed below:

Serial No.	Difference in error %	Requirement %
99710339	0,02	$\leq 1,5$

The meter meets the requirements.

4.6 Self-heating

4.6.1 Influence of self-heating on the accuracy

The changes in the error as a result of self-heating with I_{max} , measured at reference voltage, reference frequency, $\cos \varphi = 1$ and also at $\cos \varphi = 0,5$ inductive, are shown in the table below. The changes were measured for at least 60 minutes after connecting the current.

Serial No.	Maximum change %	
	$\cos \varphi = 1$	$\cos \varphi = 0,5$
99710285	0,09 (req. $\leq 0,7$)	0,13 (req. $\leq 1,0$)
99710338	0,07 (req. $\leq 0,7$)	0,14 (req. $\leq 1,0$)

The meter meets the requirements.

4.6.2 Heating

This test was carried out on meter no. 99710285 and 99710338.

The meter was powered with 115% of nominal voltage and maximum current for 2 hours. The maximum temperature rise of the meters was 18 K (req. ≤ 25 K).

The meter meets the requirements.

4.7 Power consumption of the voltage and current circuits

The meters were tested for power consumption at a nominal voltage. The maximum values are shown in the table below. The power consumption for the current circuits was measured at nominal current.

Serial number	99710286		99710288		99710288	
Reference Voltage	240 V		240 V		110V	
Voltage circuit	VA	W	VA	W	VA	W
L1	0,86	0,33	0,83	0,33	0,40	0,21
L2	0,87	0,35	0,85	0,35	0,40	0,22
L3	0,82	0,35	0,79	0,35	0,40	0,22
Current circuit	VA		VA		VA	
L1	0,02		0,02		< 0,01	
L2	0,02		0,02		< 0,01	
L3	0,02		0,02		< 0,01	

The maximum permissible power consumption for the voltage circuits is 10 VA and 2 W (including the power supply) and for the current circuits 4 VA. The meter meets the requirements.

4.8 Fast transient burst test

This test was carried out on meter no. 99710333.

4.8.1 Test method

The test was carried out with the current circuit carrying reference current.

The test was carried out in accordance with clause 7.4.7 of EN 50470-1 and 7.5.4 of IEC 62052-11.

4.8.2 Test levels

The test was carried out with a test voltage of 4 kV, in accordance with EN 50470-1 and IEC 62052-11.

4.8.3 Test results

The meter was not influenced by the fast transient burst.

The influence of the fast transient burst was less than 0,5% in all cases.

The meter meets the requirements.

4.9 Electrostatic discharges

This test was carried out on meter no. 99710333.

4.9.1 Test method

The test was carried out in accordance with clause 7.4.5 of EN 50470-1 and 7.5.2 of IEC 62052-11.

4.9.2 Test levels

A discharge voltage of 15 kV (air discharge) respectively 8 kV (contact- / indirect discharge) was applied in accordance with EN 50470-1 and IEC 62052-11.

4.9.3 Test results

The tests with electrostatic discharges did not cause any disturbances of the meter functions.

The meter meets the requirements.

4.10 Immunity to electromagnetic RF fields

This test was carried out on meter no. 99710333.

4.10.1 Test method

The test with an electromagnetic field was carried out in a GTEM cell in the frequency range from 80 MHz to 2 GHz. The test was carried out in accordance with clause 7.4.6 of EN 50470-1 and 7.5.3 of IEC 62052-11.

The meter was tested at reference voltage.

4.10.2 Test levels

At a field strength of 10 V/m the meter was tested at reference current.

At a field strength of 30 V/m the meter was tested without current.

4.10.3 Test results

The measured variation in error of the meter due to the electromagnetic field was less than 0,5%.

The maximum allowed variation according to EN 50470-3 and IEC 62053-21 is 2,0%.

The maximum allowed variation according to IEC 62053-23 is 3,0%.

Without current in the current circuits the RF field did not produce a change in the register.

The meter meets the requirements.

4.11 Immunity to conducted disturbances induced by RF fields

This test was carried out on meter no. 99710333.

4.11.1 Test method

The test for immunity to conducted disturbances induced by radio frequency fields was carried out using CDNs in the frequency range from 150 kHz to 80 MHz. The test was carried out in accordance with clause 7.4.8 of EN 50470-1 and 62052-11. The meter was tested at reference voltage.

4.11.2 Test levels

At a field strength of 10 V_{emf} the meter was tested at reference current and without current.

4.11.3 Test results

The measured variation in error of the meter due to the electromagnetic field was less than 0,5%.

The maximum allowed variation according to EN 50470-3 and IEC 62053-21 is 2,0%.

The maximum allowed variation according to IEC 62053-23 is 3,0%.

Without current in the current circuits the RF field did not produce a change in the register.

The meter meets the requirements.

4.12 Radio interference measurement

This test was carried out on meter no. 99710333 (conducted) and 99710340 (radiated).

4.12.1 Test levels

The test levels were taken from EN 50470-1 clause 7.4.13 and IEC 62052-11 clause 7.5.8. The test was carried out in accordance with EN 55022 and CISPR 22.

4.12.2 Test results

The maximum peak values measured in the frequency range from 0,15 MHz to 30 MHz (according to EN 55022 and CISPR 22) were measured at 162 kHz, QP on L3 (11 dB below the limit) and at 350 kHz, QP on L2 (11 dB below the limit).

In the frequency range from 30 to 1000 MHz the maximum peak value was measured at 51 Mhz, QP, vertical polarization (8 dB below the limit).

4.13 Voltage dips and short interruptions

This test was carried out on meter no. 99710286, 99710332 and 99710288.

4.13.1 Test levels

The test levels were taken from EN 50470-1 clause 7.4.4 and IEC 62052-11 clause 7.1.2.

4.13.2 Test results

The results of the measurements are mentioned below.

Applied phenomena in the line voltage	Duration of the phenomenon	Requirement	Result
Variation in the line voltage $V_{ref} - 50\%$	1 min.	1 min.	Pass
Interruption in the line voltage 3 times with 50 ms restoring time	See annex C of EN 50470-1 or annex B of IEC 62052-11		Pass
Interruption in the line voltage 50Hz	20 ms	20 ms	Pass

The meter meets the requirements.

4.14 Surge immunity test

This test was carried out on meter no. 99710333.

4.14.1 Test method

The test was carried out in accordance with clause 7.4.9 of EN 50470-1 and clause 7.5.6 of IEC 62052-11 using a surge generator with impedances as specified in the standard.

4.14.2 Test levels

The test levels were taken from EN 50470-1 clause 7.4.9 and IEC 62052-11 clause 7.5.6.

4.14.3 Test results

The meter was not influenced by the surges. The surges did not produce a change in the register. The meter did not show any damage after the tests.

The meter meets the requirements.

4.15 Damped oscillatory waves immunity test

This test is not applicable to direct connected meters.

4.16 Insulation

This test was carried out on meter no. 99710337 and 99710288.

The auxiliary circuits operating at a reference voltage equal to or below 40 V were connected to earth.

4.16.1 Impulse voltage test

The test was carried out in accordance with clause 7.3.3 of EN 50470-1 and 7.3.2 of IEC 62052-11.

Applied pulse	1,2 / 50 μ s pulse ; $R_i = 500 \Omega$			
	Specification of circuits(s)	Amplitude (open voltage)		Result
			Requirement	
Between input leads (differential mode)	Between leads voltage circuit	6 kV	6 kV	Pass
Between input circuits and earth (common mode)	Between system and earth	6 kV	6 kV	Pass

The change in accuracy due to the test was < 0,01%. The meter meets the requirement.

4.16.2 A.C. voltage test

The test was carried out in accordance with clause 7.3.4 of EN 50470-1 and clause 7.3.3 of IEC 62052-11.

A voltage of 4 kV (Protective class II) at a frequency of 50 Hz was applied between system and earth.

During the tests no flashovers were observed. After the tests had been carried out no degradation in the measured insulation resistance was found.

The change in accuracy due to the test was < 0,01%.

The meter meets the requirement.

4.17 Immunity to conducted disturbances 2-150 kHz

This test was carried out on meter no. 99710333.

4.17.1 Test method

Immunity to conducted disturbances in the frequency range 2-150 kHz was tested in accordance with EN 61000-4-19 dated August 2014.

The test was carried out for current only, while applying the performance criteria, including the value of the disturbing current, as laid down in chapter 7 (table 2 and 3) of document CLC/TR 50579 (dated June 2012).

The test was carried out by direct injection using a generator, amplifier and decoupling impedances. The meter was tested at reference voltage and reference current.

4.17.2 Test levels

The wave profiles of EN 61000-4-19 were applied.

The value of the disturbing current was 2 A in the range of 2 kHz to 30 kHz and 1 A in the range of 30 kHz to 150 kHz; in accordance with table 2 of CLC/TR 50579.

4.17.3 Test results

The measured variation in error of the meter due to the disturbing current was less than 0,5 %.

The maximum allowed variation according to of CLC/TR 50579 is 4 %.

The meter meets the requirements.

5 MAXIMUM PERMISSIBLE ERROR

In accordance with clause 8.4 of EN 50470-3, the composite error is calculated at several temperatures and tested to the maximum permissible error. The calculated values of the composite error are shown in the following table.

Serial No.: 99710338

I in % of I _{ref}	cos φ	Phase	Composite error %								
			-40 °C	-25 °C	-10 °C	5 °C	30 °C	40 °C	55 °C	70 °C	80 °C
5	1	RST	0,13%	0,12%	0,10%	0,07%	0,06%	0,07%	0,10%	0,14%	0,16%
10	1	RST	0,14%	0,11%	0,10%	0,08%	0,06%	0,08%	0,11%	0,14%	0,16%
10	0,5 ind.	RST	0,19%	0,16%	0,15%	0,13%	0,11%	0,13%	0,18%	0,23%	0,26%
10	0,8 cap.	RST	0,11%	0,10%	0,08%	0,05%	0,04%	0,07%	0,10%	0,12%	0,11%
10	1	R	0,22%	0,19%	0,14%	0,10%	0,07%	0,09%	0,14%	0,20%	0,23%
10	0,5 ind.	R	0,28%	0,22%	0,18%	0,14%	0,10%	0,11%	0,18%	0,24%	0,28%
10	1	S	0,09%	0,09%	0,08%	0,07%	0,07%	0,09%	0,11%	0,11%	0,12%
10	0,5 ind.	S	0,21%	0,18%	0,17%	0,16%	0,16%	0,18%	0,20%	0,21%	0,22%
10	1	T	0,08%	0,08%	0,06%	0,05%	0,05%	0,07%	0,11%	0,14%	0,16%
10	0,5 ind.	T	0,14%	0,13%	0,13%	0,12%	0,11%	0,13%	0,17%	0,23%	0,27%
I _{max}	1	RST	0,14%	0,12%	0,10%	0,07%	0,06%	0,07%	0,10%	0,13%	0,15%
I _{max}	0,5 ind.	RST	0,19%	0,16%	0,13%	0,09%	0,07%	0,10%	0,19%	0,31%	0,21%
I _{max}	0,8 cap.	RST	0,15%	0,14%	0,12%	0,11%	0,10%	0,11%	0,11%	0,11%	0,16%
I _{max}	1	R	0,26%	0,21%	0,16%	0,10%	0,06%	0,08%	0,12%	0,16%	0,44%
I _{max}	0,5 ind.	R	0,30%	0,25%	0,19%	0,14%	0,10%	0,14%	0,19%	0,28%	0,09%
I _{max}	1	S	0,10%	0,09%	0,07%	0,05%	0,04%	0,05%	0,06%	0,07%	0,18%
I _{max}	0,5 ind.	S	0,17%	0,16%	0,13%	0,08%	0,06%	0,13%	0,29%	0,56%	0,39%
I _{max}	1	T	0,08%	0,07%	0,06%	0,06%	0,04%	0,07%	0,09%	0,12%	0,06%
I _{max}	0,5 ind.	T	0,17%	0,16%	0,15%	0,14%	0,13%	0,15%	0,20%	0,31%	0,81%

Serial No.: 99710285

I in % of I _{ref}	cos φ	Phase	Composite error %								
			-40 °C	-25 °C	-10 °C	5 °C	30 °C	40 °C	55 °C	70 °C	80 °C
5	1	RST	0,20%	0,16%	0,12%	0,09%	0,06%	0,09%	0,15%	0,18%	0,20%
10	1	RST	0,19%	0,16%	0,10%	0,08%	0,05%	0,08%	0,14%	0,18%	0,20%
10	0,5 ind.	RST	0,22%	0,19%	0,16%	0,13%	0,12%	0,14%	0,21%	0,25%	0,29%
10	0,8 cap.	RST	0,18%	0,16%	0,11%	0,08%	0,04%	0,07%	0,13%	0,16%	0,18%
10	1	R	0,19%	0,16%	0,12%	0,09%	0,07%	0,09%	0,14%	0,17%	0,20%
10	0,5 ind.	R	0,26%	0,22%	0,19%	0,16%	0,12%	0,14%	0,18%	0,22%	0,23%
10	1	S	0,21%	0,17%	0,12%	0,09%	0,06%	0,09%	0,14%	0,18%	0,20%
10	0,5 ind.	S	0,25%	0,22%	0,19%	0,15%	0,12%	0,15%	0,22%	0,26%	0,31%
10	1	T	0,17%	0,14%	0,11%	0,09%	0,06%	0,09%	0,14%	0,19%	0,21%
10	0,5 ind.	T	0,21%	0,18%	0,14%	0,12%	0,10%	0,13%	0,20%	0,24%	0,27%
I _{max}	1	RST	0,19%	0,16%	0,12%	0,08%	0,04%	0,07%	0,11%	0,16%	0,19%
I _{max}	0,5 ind.	RST	0,23%	0,19%	0,16%	0,11%	0,07%	0,10%	0,16%	0,24%	0,23%
I _{max}	0,8 cap.	RST	0,18%	0,16%	0,13%	0,11%	0,11%	0,12%	0,14%	0,16%	0,21%
I _{max}	1	R	0,18%	0,15%	0,11%	0,07%	0,04%	0,06%	0,11%	0,14%	0,31%
I _{max}	0,5 ind.	R	0,24%	0,22%	0,18%	0,15%	0,14%	0,15%	0,21%	0,30%	0,18%
I _{max}	1	S	0,20%	0,16%	0,12%	0,07%	0,03%	0,06%	0,10%	0,14%	0,17%
I _{max}	0,5 ind.	S	0,24%	0,20%	0,15%	0,10%	0,08%	0,10%	0,19%	0,30%	0,41%
I _{max}	1	T	0,16%	0,13%	0,10%	0,06%	0,04%	0,06%	0,11%	0,17%	0,17%
I _{max}	0,5 ind.	T	0,22%	0,19%	0,15%	0,11%	0,09%	0,11%	0,18%	0,24%	0,44%

6 DURABILITY AND RELIABILITY

In accordance with chapter 9 and 10 of EN 50470-3 durability and reliability of the meters were verified.

In order to conform to these clauses the manufacturer provided the documentation for verification to KEMA Laboratories and additional verification tests were carried out on request of KEMA Laboratories.

The meter meets the requirements.

7 SOFTWARE AND PROTECTION AGAINST CORRUPTION

In accordance with chapter 11 of EN 50470-3 software and protection against corruption of the meters were verified.

In order to conform to these clauses the manufacturer provided the documentation for verification to KEMA Laboratories. The description of applied methods was based on Welmec guide 7.2 and includes application of the following methods (for risk class C):

I3 – Specific software requirements (Active electrical energy meters)

P – Specific requirements for type P (built-for-Purpose measuring instruments)

L - Specific software Requirements for Long term storage

The final version of the legally relevant software to be applied is version 1.0.0 with CRC code: 5DCB8332.

The meter meets the requirements.

Appendix A Accuracy test results

Accuracy test results, serial number 99710285.

240/415 V		Wh				
I in % of I _{ref}	3/1 ph	Percentage error at cos φ =				
		1	0,5 ind.	0,8 cap.	0,25 ind.	0,5 cap.
5	3ph	0,06%				
5*	3ph	0,02%				
10	3ph	0,04%	0,11%	0,04%		
10	1ph,1	0,06%	0,12%			
10	1ph,2	0,05%	0,12%			
10	1ph,3	0,04%	0,09%			
20	3ph	0,04%	0,09%	0,02%	0,16%	0,00%
20	1ph,1		0,11%			
20	1ph,2		0,09%			
20	1ph,3		0,07%			
50	3ph	0,03%	0,06%	0,01%	0,11%	- 0,01%
100	3ph	0,03%	0,04%	0,02%	0,08%	0,01%
100*	3ph	0,03%	0,05%	0,02%		
100	1ph,1	0,04%	0,06%			
100	1ph,2	0,02%	0,05%			
100	1ph,3	0,02%	0,05%			
200	3ph	0,02%	0,02%	0,03%		
½I _{max}	3ph	0,01%	- 0,11%	0,07%		
¾ I _{max}	3ph	0,02%	- 0,12%	0,09%		
I _{max}	3ph	0,04%	- 0,07%	0,10%		
I _{max}	1ph,1	0,03%	- 0,13%			
I _{max}	1ph,2	0,02%	- 0,06%			
I _{max}	1ph,3	0,02%	- 0,08%			

* Reverse energy

Accuracy test results, serial number 99710285.

110/190 V		Wh				
I in % of I _{ref}	3/1 ph	Percentage error at cos φ =				
		1	0,5 ind.	0,8 cap.	0,25 ind.	0,5 cap.
5	3ph	0,01%				
5*	3ph	0,00%				
10	3ph	0,00%	0,04%	0,00%		
10	1ph,1	0,02%	0,03%			
10	1ph,2	0,01%	0,05%			
10	1ph,3	0,00%	0,03%			
20	3ph	0,00%	0,02%	- 0,01%	0,06%	- 0,01%
20	1ph,1		0,02%			
20	1ph,2		0,03%			
20	1ph,3		0,01%			
50	3ph	- 0,01%	0,00%	- 0,01%	0,00%	- 0,02%
100	3ph	- 0,01%	- 0,01%	- 0,01%	- 0,02%	- 0,01%
100*	3ph	- 0,01%	0,00%	0,00%		
100	1ph,1	0,00%	- 0,01%			
100	1ph,2	- 0,01%	- 0,01%			
100	1ph,3	- 0,01%	0,00%			
200	3ph	- 0,01%	- 0,04%	0,00%		
½I _{max}	3ph	- 0,02%	- 0,17%	0,00%		
¾ I _{max}	3ph	- 0,01%	- 0,20%	0,04%		
I _{max}	3ph	0,00%	- 0,16%	0,06%		
I _{max}	1ph,1	- 0,02%	- 0,21%			
I _{max}	1ph,2	- 0,02%	- 0,16%			
I _{max}	1ph,3	- 0,03%	- 0,16%			

* Reverse energy

Accuracy test results, serial number 99710338.

240/415 V		Wh				
I in % of I _{ref}	3/1 ph	Percentage error at cos φ =				
		1	0,5 ind.	0,8 cap.	0,25 ind.	0,5 cap.
5	3ph	0,05%				
5*	3ph	0,02%				
10	3ph	0,05%	0,11%	0,03%		
10	1ph,1	0,06%	0,09%			
10	1ph,2	0,06%	0,15%			
10	1ph,3	0,03%	0,10%			
20	3ph	0,05%	0,10%	0,03%	0,17%	0,01%
20	1ph,1		0,08%			
20	1ph,2		0,13%			
20	1ph,3		0,09%			
50	3ph	0,04%	0,07%	0,02%	0,10%	0,00%
100	3ph	0,04%	0,06%	0,03%	0,08%	0,02%
100*	3ph	0,04%	0,06%	0,03%		
100	1ph,1	0,05%	0,05%			
100	1ph,2	0,04%	0,06%			
100	1ph,3	0,03%	0,06%			
200	3ph	0,03%	0,02%	0,04%		
½I _{max}	3ph	0,03%	- 0,09%	0,07%		
¾ I _{max}	3ph	0,03%	- 0,11%	0,10%		
I _{max}	3ph	0,05%	- 0,05%	0,10%		
I _{max}	1ph,1	0,05%	- 0,09%			
I _{max}	1ph,2	0,03%	- 0,02%			
I _{max}	1ph,3	0,02%	- 0,12%			

* Reverse energy

Accuracy test results, serial number 99710338.

110/190 V		Wh				
I in % of I _{ref}	3/1 ph	Percentage error at cos φ =				
		1	0,5 ind.	0,8 cap.	0,25 ind.	0,5 cap.
5	3ph	0,00%				
5*	3ph	- 0,02%				
10	3ph	0,00%	0,03%	0,00%		
10	1ph,1	0,00%	0,01%			
10	1ph,2	0,01%	0,06%			
10	1ph,3	- 0,01%	0,02%			
20	3ph	0,00%	0,02%	0,00%	0,05%	0,00%
20	1ph,1		0,01%			
20	1ph,2		0,05%			
20	1ph,3		0,01%			
50	3ph	0,00%	0,00%	0,00%	0,02%	- 0,01%
100	3ph	0,00%	0,00%	0,00%	- 0,03%	0,00%
100*	3ph	0,00%	0,00%	0,00%		
100	1ph,1	0,00%	- 0,01%			
100	1ph,2	0,00%	0,00%			
100	1ph,3	- 0,01%	- 0,02%			
200	3ph	0,00%	- 0,04%	0,00%		
½I _{max}	3ph	- 0,01%	- 0,12%	0,00%		
¾ I _{max}	3ph	- 0,01%	- 0,19%	0,05%		
I _{max}	3ph	0,00%	- 0,14%	0,06%		
I _{max}	1ph,1	0,00%	- 0,17%			
I _{max}	1ph,2	- 0,02%	- 0,11%			
I _{max}	1ph,3	- 0,03%	- 0,20%			

* Reverse energy

Accuracy test results, serial number 99710285.

240/415 V		varh				
I in % of I _{ref}	3/1 ph	Percentage error at sin φ =				
		1	0,5 ind.	0,5 cap.	0,25 ind.	0,25 cap.
5	3ph	-0,54%				
5*	3ph	0,60%				
10	3ph	-0,26%	-0,59%	-0,50%		
10	1ph,1	-0,26%				
10	1ph,2	-0,26%				
10	1ph,3	-0,26%				
20	3ph	-0,11%	-0,29%	-0,21%	-0,63%	-0,43%
20	1ph,1		-0,30%			
20	1ph,2		-0,29%			
20	1ph,3		-0,29%			
50	3ph	-0,06%	-0,18%			
100	3ph	-0,01%	-0,07%	-0,04%	-0,19%	-0,10%
100*	3ph	0,06%	0,09%	0,12%		
100	1ph,1	-0,01%	-0,07%			
100	1ph,2	-0,02%	-0,09%			
100	1ph,3	-0,01%	-0,06%			
200	3ph	0,00%	-0,01%			
½I _{max}	3ph	0,00%	0,02%	-0,05%	0,02%	-0,32%
¾ I _{max}	3ph	0,01%	0,15%			
I _{max}	3ph	0,03%	0,15%	-0,08%	0,29%	-0,23%
I _{max}	1ph,1	0,01%	0,17%			
I _{max}	1ph,2	0,01%	0,11%			
I _{max}	1ph,3	0,01%	0,10%			

* Exported energy

Accuracy test results, serial number 99710285.

110/190 V		varh				
I in % of I _{ref}	3/1 ph	Percentage error at sin φ =				
		1	0,5 ind.	0,5 cap.	0,25 ind.	0,25 cap.
5	3ph	-0,27%				
5*	3ph	0,26%				
10	3ph	-0,15%	-0,28%	-0,25%		
10	1ph,1	-0,14%				
10	1ph,2	-0,14%				
10	1ph,3	-0,15%				
20	3ph	-0,07%	-0,16%	-0,12%	-0,30%	-0,23%
20	1ph,1		-0,14%			
20	1ph,2		-0,16%			
20	1ph,3		-0,16%			
50	3ph	-0,05%	-0,10%			
100	3ph	-0,03%	-0,05%	-0,05%	-0,09%	-0,10%
100*	3ph	0,00%	0,02%	0,02%		
100	1ph,1	-0,03%	-0,04%			
100	1ph,2	-0,03%	-0,06%			
100	1ph,3	-0,03%	-0,06%			
200	3ph	-0,03%	-0,01%			
½I _{max}	3ph	-0,03%	0,02%	-0,08%	0,05%	-0,22%
¾ I _{max}	3ph	-0,02%	0,13%			
I _{max}	3ph	0,00%	0,13%	-0,13%	0,29%	-0,31%
I _{max}	1ph,1	-0,02%	0,16%			
I _{max}	1ph,2	-0,02%	0,08%			
I _{max}	1ph,3	-0,03%	0,07%			

* Exported energy

Accuracy test results, serial number 99710338.

240/415 V		varh				
I in % of I _{ref}	3/1 ph	Percentage error at sin φ =				
		1	0,5 ind.	0,5 cap.	0,25 ind.	0,25 cap.
5	3ph	-0,26%				
5*	3ph	0,32%				
10	3ph	-0,11%	-0,30%	-0,21%		
10	1ph,1	-0,03%				
10	1ph,2	-0,27%				
10	1ph,3	-0,03%				
20	3ph	-0,04%	-0,14%	-0,04%	-0,33%	-0,14%
20	1ph,1		-0,04%			
20	1ph,2		-0,34%			
20	1ph,3		-0,04%			
50	3ph	-0,02%	-0,11%			
100	3ph	0,00%	-0,03%	0,00%	-0,11%	-0,04%
100*	3ph	0,06%	0,07%	0,10%		
100	1ph,1	0,01%	0,00%			
100	1ph,2	-0,01%	-0,09%			
100	1ph,3	0,01%	0,00%			
200	3ph	0,01%	0,01%			
½I _{max}	3ph	0,01%	-0,01%	0,02%	-0,09%	-0,19%
¾ I _{max}	3ph	0,02%	0,16%			
I _{max}	3ph	0,04%	0,16%	-0,06%	0,28%	-0,20%
I _{max}	1ph,1	0,03%	0,17%			
I _{max}	1ph,2	0,01%	0,06%			
I _{max}	1ph,3	0,01%	0,16%			

* Exported energy

Accuracy test results, serial number 99710338.

110/190 V		varh				
I in % of I _{ref}	3/1 ph	Percentage error at sin φ =				
		1	0,5 ind.	0,5 cap.	0,25 ind.	0,25 cap.
5	3ph	-0,14%				
5*	3ph	0,13%				
10	3ph	-0,06%	-0,17%	-0,10%		
10	1ph,1	-0,02%				
10	1ph,2	-0,13%				
10	1ph,3	-0,03%				
20	3ph	-0,03%	-0,08%	-0,03%	-0,18%	-0,07%
20	1ph,1		-0,02%			
20	1ph,2		-0,19%			
20	1ph,3		-0,05%			
50	3ph	-0,03%	-0,07%			
100	3ph	-0,01%	-0,02%	-0,03%	-0,04%	-0,07%
100*	3ph	0,00%	0,02%	0,01%		
100	1ph,1	-0,01%	0,00%			
100	1ph,2	-0,02%	-0,06%			
100	1ph,3	-0,01%	-0,01%			
200	3ph	-0,01%	0,01%			
½I _{max}	3ph	-0,02%	0,11%	-0,17%	0,27%	-0,37%
¾ I _{max}	3ph	-0,01%	0,14%			
I _{max}	3ph	0,00%	0,13%	-0,11%	0,28%	-0,27%
I _{max}	1ph,1	0,00%	0,15%			
I _{max}	1ph,2	-0,01%	0,03%			
I _{max}	1ph,3	-0,02%	0,13%			

* Exported energy

Appendix B Photographs of the meter









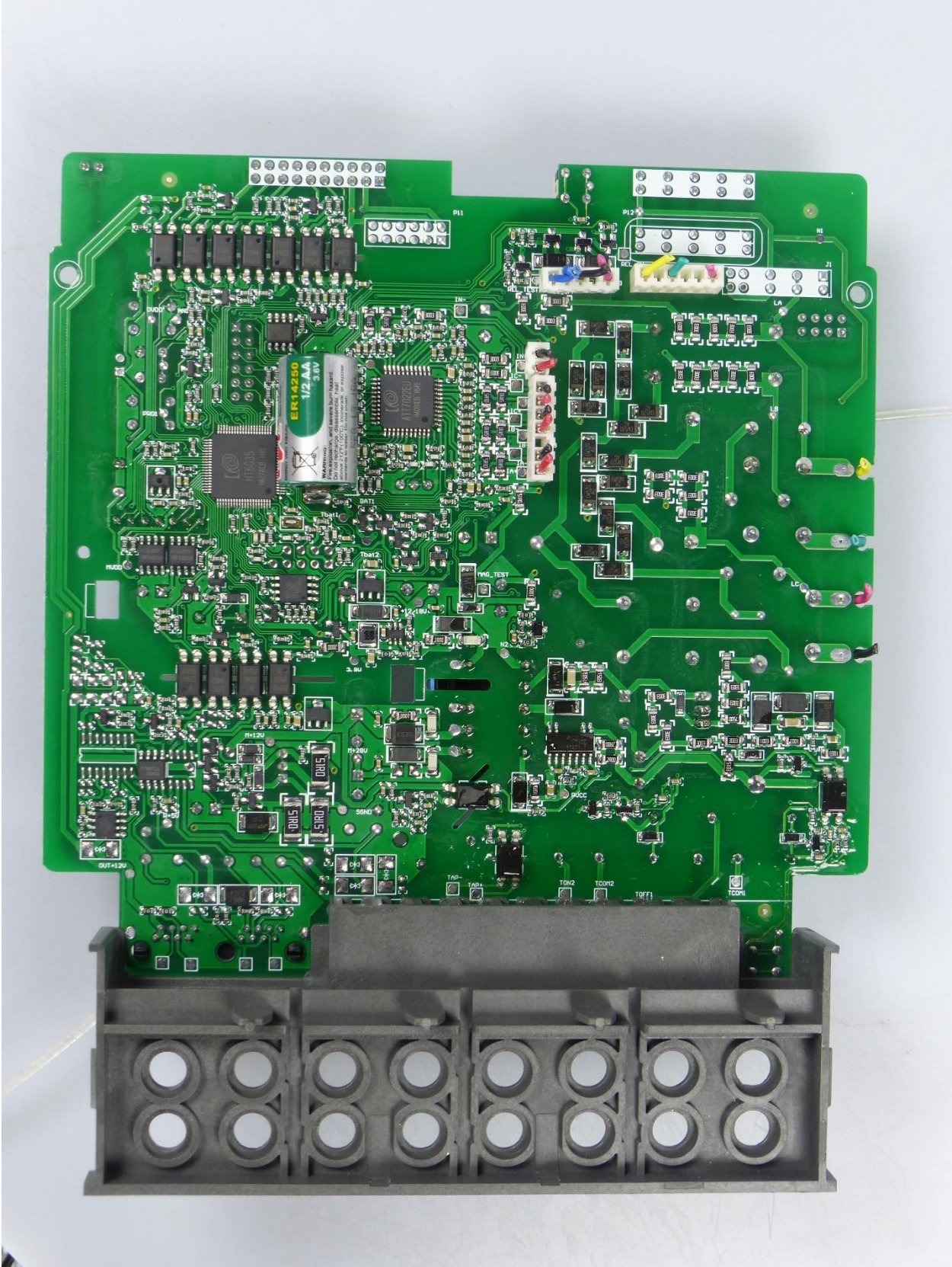

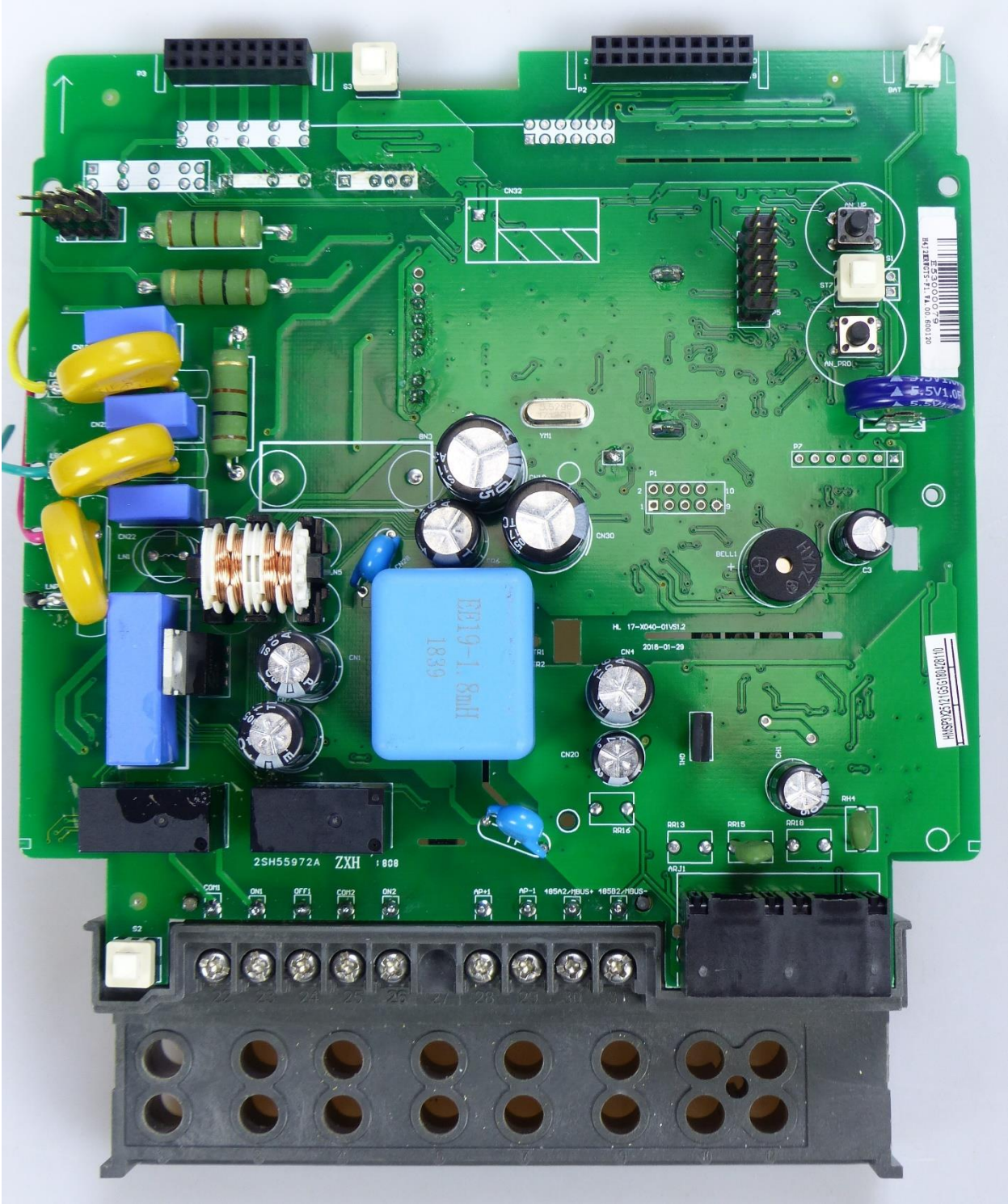

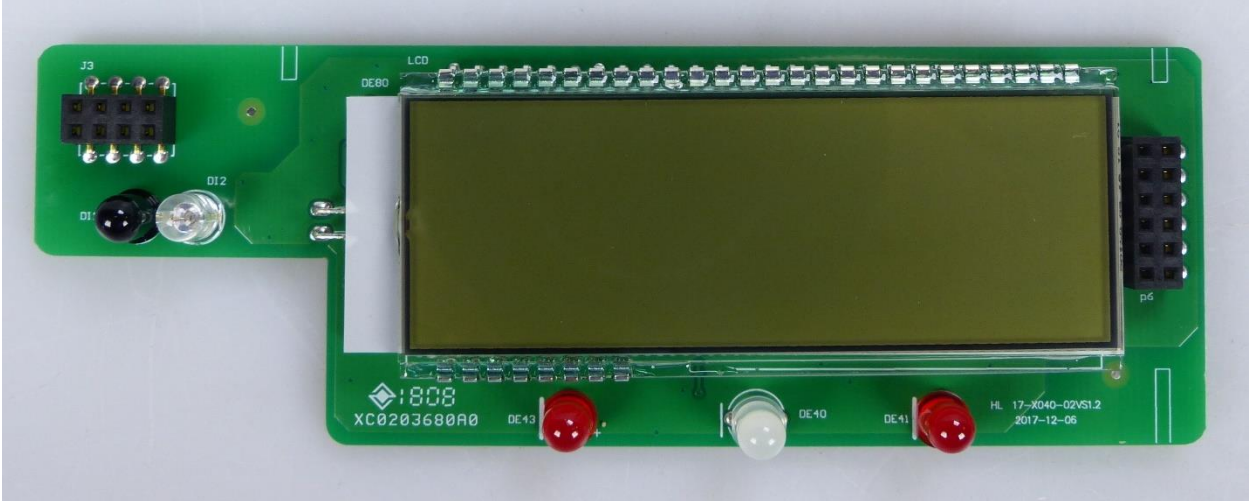
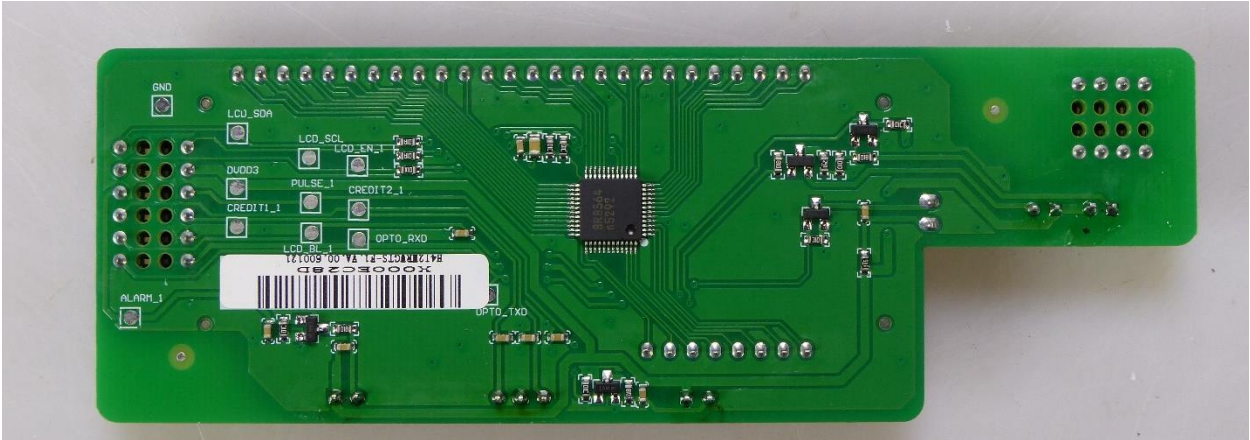

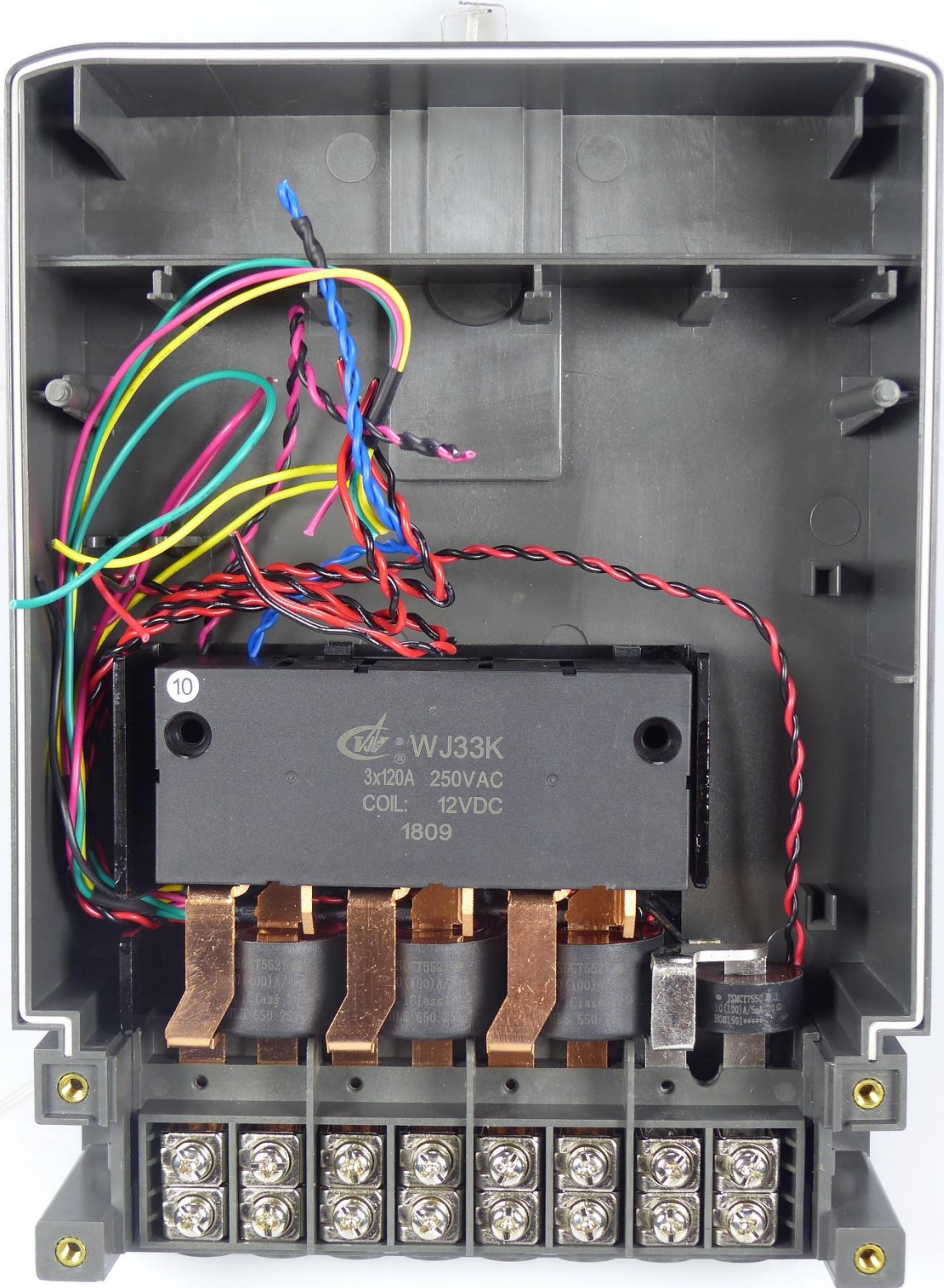



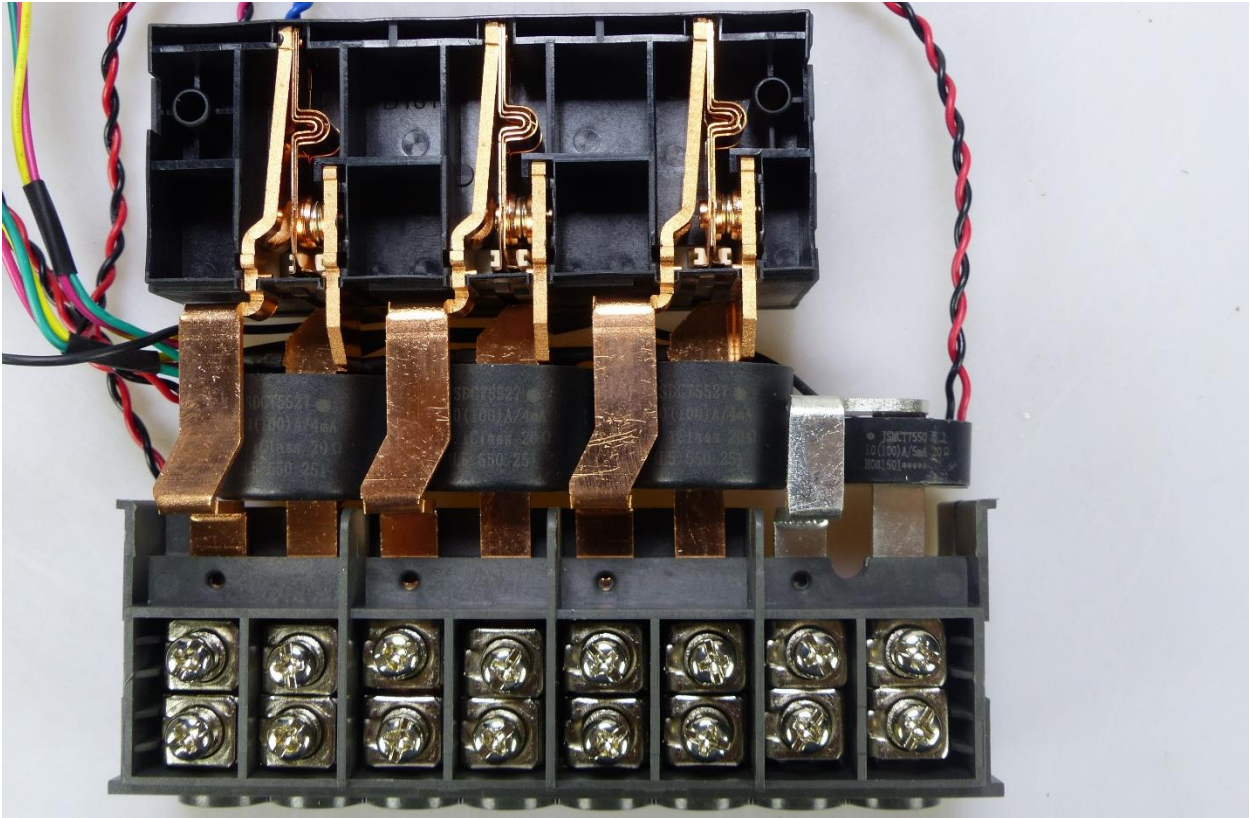
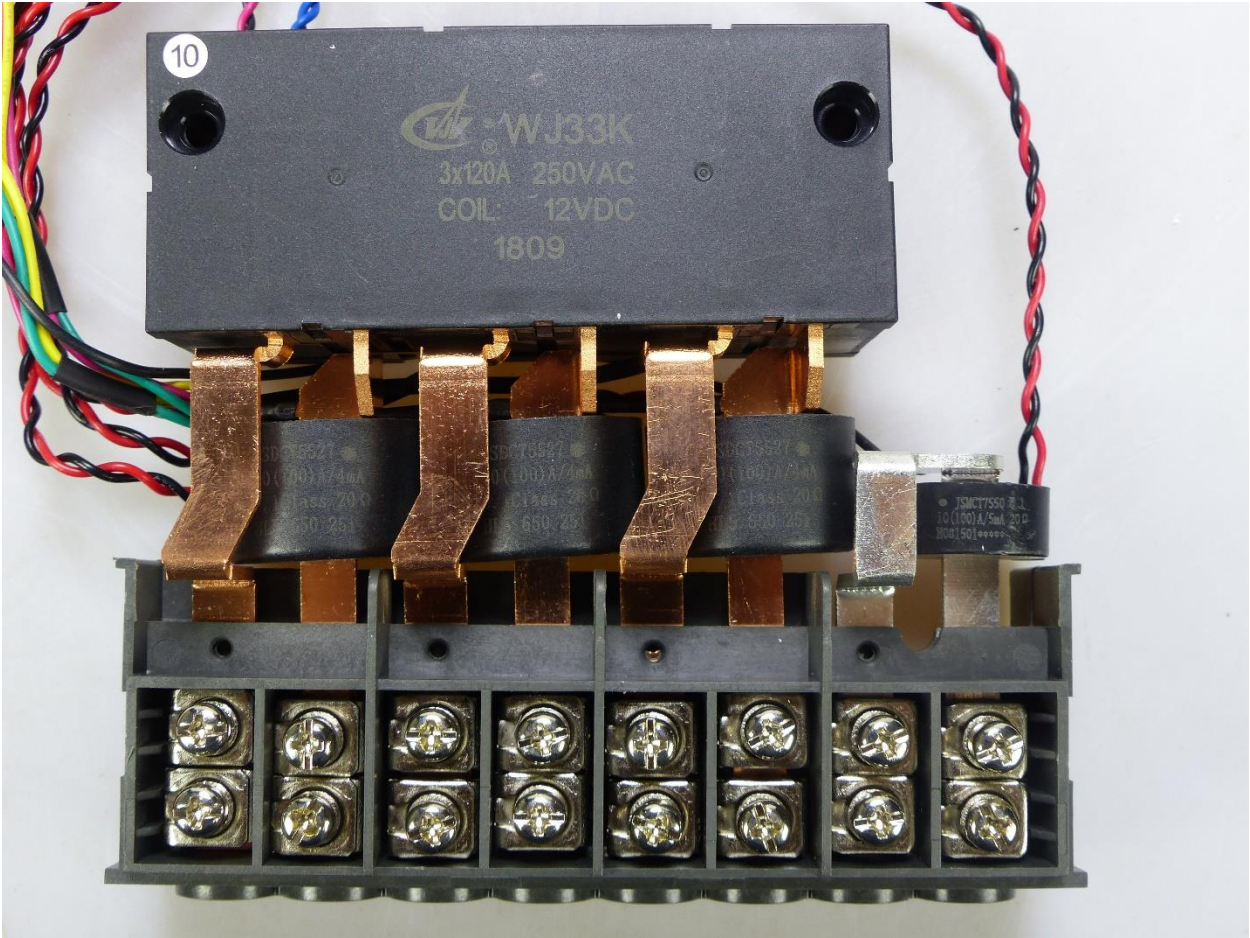

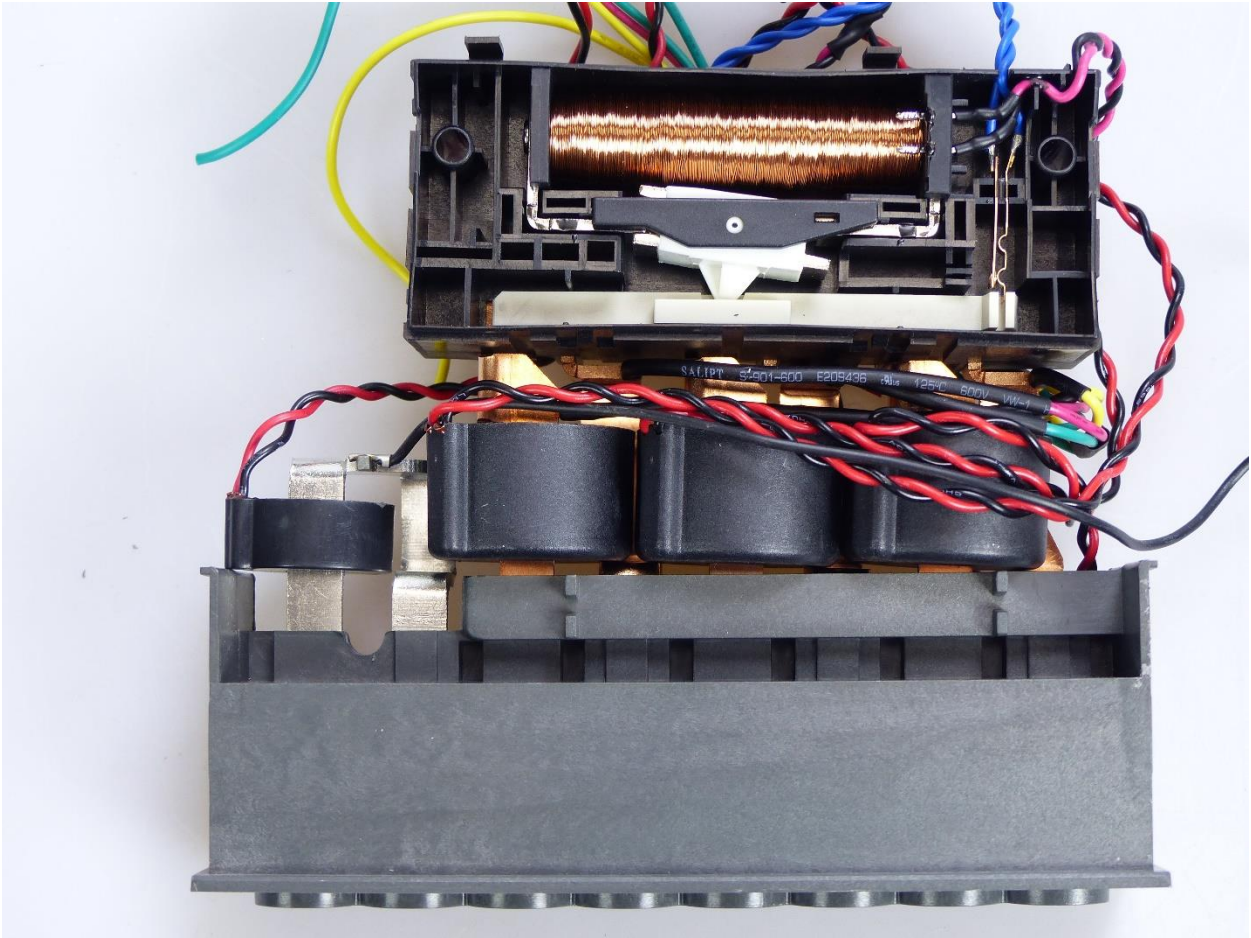

Appendix C Cross-reference table and checklist for static meters

Chapter	Test	IEC 62052-11 clause	IEC 62053-21 clause	EN 50470-1 clause	EN 50470-3 clause	Applied standards	
3	Marking of the meter	5.12		5.12		IEC 60387, IEC 60417-2, EN 62053-52	Pass
4.1	General- and mechanical requirements	5		5.1	5		Pass
4.1.3	Spring hammer test	5.2.2.1		5.2.2.1.		EN-IEC 60068-2-75	Pass
4.1.4	Shock test	5.2.2.2		5.2.2.2		EN-IEC 60068-2-27	Pass
4.1.5	Vibration test	5.2.2.3		5.2.2.3		EN-IEC 60068-2-6	Pass
4.1.6	Protection against penetration of dust and water	5.9		5.9		EN-IEC 60529	Pass
4.1.7	Terminal block material test	5.4		5.4		ISO 75-2	Pass
4.1.8	Resistance to heat and fire	5.8		5.8		EN-IEC 60695-2-11	Pass
4.2.2	Dry heat test	6.3.1		6.3.2.		EN-IEC 60068-2-2	Pass
4.2.3	Cold test	6.3.2		6.3.3.		EN-IEC 60068-2-1	Pass
4.2.4	Damp heat cyclic test	6.3.3		6.3.4.		EN-IEC 60068-2-30	Pass
4.2.5	Solar radiation test	6.3.4		6.3.5.		EN-IEC 60068-2-5	N.A.
4.3	Accuracy measurement at different loads		8.1		8.1		Pass
4.3.1	Interpretation of test results		8.6		8.7.3.		Pass
4.3.2	Meter constant		8.4		8.7.10		Pass
4.3.3	Starting current		8.3		8.7.9.4.		Pass
4.3.4	Test of no load condition		8.3		8.7.9.3.		Pass
4.4.1	Influence of ambient temperature variation		8.2		8.7.5.2.		Pass
4.4.2	Auxiliary voltage variation		8.2				N.A.
4.4.3	Voltage variation		8.2		8.7.5.3.		Pass
4.4.4	Frequency variation		8.2		8.7.5.4		Pass
4.4.5	Magnetic induction of external origin 0,5 mT		8.2		8.7.7.11	EN-IEC 61000-4-8	Pass
4.4.6	Harmonic components		8.2		8.7.7.7.		Pass
4.4.7	D.C. and even harmonics		8.2		8.7.7.8.		Pass
4.4.8	Odd harmonics in the a.c. current circuit		8.2		8.7.7.9		Pass
4.4.9	Sub-harmonics in the a.c. current circuit		8.2		8.7.7.9.		Pass
4.4.10	Reversed phase sequence		8.2		8.7.7.3.		Pass
4.4.11	Voltage unbalance		8.2		8.7.7.4.		Pass
4.4.12	Continuous magnetic induction of external origin		8.2	7.4.11	8.7.7.10		Pass
4.4.13	Operation of accessories		8.2		8.7.7.13		Pass
4.4.14	Immunity to earth fault	7.4			8.7.7.6.		N.A.

Chapter	Test	IEC 62052-11 clause	IEC 62053-21 clause	EN 50470-1 clause	EN 50470-3 clause	Applied standards	
4.5	Influence of short-time overcurrents		7.2		8.7.8		Pass
4.6.1	Influence of self heating		7.3		8.7.7.5.		Pass
4.6.2	Heating	7.2		7.2.			Pass
4.7	Power consumption		7.1		7.1		Pass
4.8	Fast transient burst test	7.5.4		7.4.7	8.7.7.14	EN-IEC 61000-4-4	Pass
4.9	Electrostatic discharges	7.5.2		7.4.5.		EN-IEC 61000-4-2	Pass
4.10	Immunity to electromagnetic RF fields	7.5.3		7.4.6.	8.7.7.12	EN-IEC 61000-4-20	Pass
4.11	Immunity to RF conducted disturbances	7.5.5		7.4.8.	8.7.7.15	EN-IEC 61000-4-6	Pass
4.12	Radio interference suppression	7.5.8		7.4.13		CISPR 22, EN 55022	Pass
4.13	Voltage dips and short interruptions	7.1.2		7.4.4.		EN-IEC 61000-4-11	Pass
4.14	Surge immunity test	7.5.6		7.4.9.		EN-IEC 61000-4-5	Pass
4.15	Damped oscillatory waves immunity test	7.5.7		7.4.10	8.7.7.16	EN-IEC 61000-4-12	N.A.
4.16.1	Impulse voltage test	7.3.2		7.3.3.		IEC 60060-1	Pass
4.16.2	A.C. voltage test	7.3.3			7.2.		Pass
5	Maximum Permissible Error				8.7.6		Pass
6	Durability				9		Pass
6	Reliability				10		Pass
7	Software and protection against corruption				11		Pass

Appendix D Checklist for Measuring Instrument Directive MID 2014/32/EU

Annex I, Essential Requirements

1	Allowable Errors	§	
1.1	Under rated operating conditions and in the absence of a disturbance, the error of measurement shall not exceed the maximum permissible error (MPE) value as laid down in the appropriate instrument-specific requirements. Unless stated otherwise in the instrument-specific annexes, MPE is expressed as a bilateral value of the deviation from the true measurement value.		Pass
1.2	Under rated operating conditions and in the presence of a disturbance, the performance requirement shall be as laid down in the appropriate instrument-specific requirements. Where the instrument is intended to be used in a specified permanent continuous electromagnetic field the permitted performance during the radiated electromagnetic field-amplitude modulated test shall be within MPE.		Pass
1.3	The manufacturer shall specify the climatic, mechanical and electromagnetic environments in which the instrument is intended to be used, power supply and other influence quantities likely to affect its accuracy, taking account of the requirements laid down in the appropriate instrument-specific annexes.	See chapter 3	Pass
1.3.1	Climatic environments The manufacturer shall specify the upper temperature limit and the lower temperature limit from any of the values in Table 1 unless otherwise specified in the Annexes III to XII, and indicate whether the instrument is designed for condensing or non-condensing humidity as well as the intended location for the instrument, i.e. open or closed.	See chapter 3. Condensing	Pass
1.3.2	(a) Mechanical environments are classified into classes M1 to M3. (b) The following influence quantities shall be considered in relation with mechanical environments: <ul style="list-style-type: none"> • vibration; • mechanical shock. 	See chapter 3 and 4.1	Pass
1.3.3	(a) Electromagnetic environments are classified into classes E1, E2 or E3, unless otherwise laid down in the appropriate instrument-specific annexes.	See chapter 3	Pass
1.3.3	(b) The following influence quantities shall be considered in relation with electromagnetic environments: <ul style="list-style-type: none"> • voltage interruptions; • short voltage reductions; • voltage transients on supply lines and/or signal lines; • electrostatic discharges; EN 29.3.2014 Official Journal of the European Union L 96/171 • radio frequency electromagnetic fields; • conducted radio frequency electromagnetic fields on supply lines and/or signal lines; 	See chapter 4	Pass

	<ul style="list-style-type: none"> surges on supply lines and/or signal lines. 		
1.3.4	<p>Other influence quantities to be considered, where appropriate, are:</p> <ul style="list-style-type: none"> voltage variation; mains frequency variation; power frequency magnetic fields; any other quantity likely to influence in a significant way the accuracy of the instrument. 	See chapter 4	Pass
1.4.1	<p>Basic rules for testing and the determination of errors</p> <p>Essential requirements specified in points 1.1 and 1.2 shall be verified for each relevant influence quantity. Unless otherwise specified in the appropriate instrument-specific annex, these essential requirements apply when each influence quantity is applied and its effect evaluated separately, all other influence quantities being kept relatively constant at their reference value.</p> <p>Metrological tests shall be carried out during or after the application of the influence quantity, whichever condition corresponds to the normal operational status of the instrument when that influence quantity is likely to occur.</p>	See chapter 4	Pass
1.4.2	<p>Ambient humidity</p> <p>(a) According to the climatic operating environment in which the instrument is intended to be used either the damp heat-steady state (non-condensing) or damp heat cyclic (condensing) test may be appropriate.</p> <p>(b) The damp heat cyclic test is appropriate where condensation is important or when penetration of vapour will be accelerated by the effect of breathing. In conditions where non-condensing humidity is a factor the damp- heat steady state is appropriate.</p>	See § 4.2	Pass
2	<p>Reproducibility</p> <p>The application of the same measurand in a different location or by a different user, all other conditions being the same, shall result in the close agreement of successive measurements. The difference between the measurement results shall be small when compared with the MPE.</p>		Pass
3	<p>Repeatability</p> <p>The application of the same measurand under the same conditions of measurement shall result in the close agreement of successive measurements. The difference between the measurement results shall be small when compared with the MPE.</p>		Pass
4	<p>Discrimination and Sensitivity</p> <p>A measuring instrument shall be sufficiently sensitive and the discrimination threshold shall be sufficiently low for the intended measurement task.</p>		Pass
5	<p>Durability</p> <p>A measuring instrument shall be designed to maintain an adequate stability of its metrological characteristics over a period of time estimated by the manufacturer, provided that it is properly installed, maintained and used according to the manufacturer's instruction when in the environmental conditions for which it is intended.</p>	See chapter 6	Pass
6	<p>Reliability</p> <p>A measuring instrument shall be designed to reduce as far as possible</p>	See chapter 6	Pass

	the effect of a defect that would lead to an inaccurate measurement result, unless the presence of such a defect is obvious.		
7	Suitability		Pass
7.1	A measuring instrument shall have no feature likely to facilitate fraudulent use, whereas possibilities for unintentional misuse shall be minimal.	See chapter 7	Pass
7.2	A measuring instrument shall be suitable for its intended use taking account of the practical working conditions and shall not require unreasonable demands of the user in order to obtain a correct measurement result.		Pass
7.3	The errors of a utility measuring instrument at flows or currents outside the controlled range shall not be unduly biased.	See Appendix A	Pass
7.4	Where a measuring instrument is designed for the measurement of values of the measurand that are constant over time, the measuring instrument shall be insensitive to small fluctuations of the value of the measurand, or shall take appropriate action.		N.A.
7.5	A measuring instrument shall be robust and its materials of construction shall be suitable for the conditions in which it is intended to be used.		Pass
7.6	A measuring instrument shall be designed so as to allow the control of the measuring tasks after the instrument has been placed on the market and put into use. If necessary, special equipment or software for this control shall be part of the instrument. The test procedure shall be described in the operation manual. When a measuring instrument has associated software which provides other functions besides the measuring function, the software that is critical for the metrological characteristics shall be identifiable and shall not be inadmissibly influenced by the associated software.		Pass
8	Protection against corruption	See chapter 7	Pass
8.1	The metrological characteristics of a measuring instrument shall not be influenced in any inadmissible way by the connection to it of another device, by any feature of the connected device itself or by any remote device that communicates with the measuring instrument.		Pass
8.2	A hardware component that is critical for metrological characteristics shall be designed so that it can be secured. Security measures foreseen shall provide for evidence of an intervention.		Pass
8.3	Software that is critical for metrological characteristics shall be identified as such and shall be secured. Software identification shall be easily provided by the measuring instrument. Evidence of an intervention shall be available for a reasonable period of time.		Pass
8.4	Measurement data, software that is critical for measurement characteristics and metrologically important parameters stored or transmitted shall be adequately protected against accidental or intentional corruption.		Pass
8.5	For utility measuring instruments the display of the total quantity supplied or the displays from which the total quantity supplied can be		Pass

	derived, whole or partial reference to which is the basis for payment, shall not be able to be reset during use.		
9	Information to be borne by and to accompany the instrument		
9.1	A measuring instrument shall bear the following inscriptions: (a) manufacturer's name, registered trade name or registered trade mark; (b) information in respect of its accuracy; and, where applicable: (c) information in respect of the conditions of use; (d) measuring capacity; (e) measuring range; (f) identity marking; (g) number of the EU-type examination certificate or the EU design examination certificate; (h) information whether or not additional devices providing metrological results comply with the provisions of this Directive on legal metrological control.		Pass
9.2	An instrument of dimensions too small or of too sensitive a composition to allow it to bear the relevant information shall have its packaging, if any, and the accompanying documents required by the provisions of this Directive suitably marked.		N.A.
9.3	The instrument shall be accompanied by information on its operation, unless the simplicity of the measuring instrument makes this unnecessary. Information shall be easily understandable and shall include where relevant: (a) rated operating conditions; (b) mechanical and electromagnetic environment classes; (c) the upper and lower temperature limit, whether condensation is possible or not, open or closed location; (d) instructions for installation, maintenance, repairs, permissible adjustments; (e) instructions for correct operation and any special conditions of use; (f) conditions for compatibility with interfaces, sub-assemblies or measuring instruments.		Pass
9.4	Groups of identical measuring instruments used in the same location or used for utility measurements do not necessarily require individual instruction manuals.		N.T.
9.5	Unless specified otherwise in an instrument-specific annex, the scale interval for a measured value shall be in the form 1×10^n , 2×10^n , or 5×10^n , where n is any integer or zero. The unit of measurement or its symbol shall be shown close to the numerical value.		Pass
9.6	A material measure shall be marked with a nominal value or a scale, accompanied by the unit of measurement used.		Pass
9.7	The units of measurement used and their symbols shall be in accordance with the provisions of Union legislation on units of measurement and their symbols.		Pass
9.8	All marks and inscriptions required under any requirement shall be clear, non-erasable, unambiguous and non-transferable.		Pass

10	Indication of result		Pass
10.1	Indication of the result shall be by means of a display or hard copy.		Pass
10.2	The indication of any result shall be clear and unambiguous and accompanied by such marks and inscriptions necessary to inform the user of the significance of the result. Easy reading of the presented result shall be permitted under normal conditions of use. Additional indications may be shown provided they cannot be confused with the metrologically controlled indications.		Pass
10.3	In the case of hard copy the print or record shall also be easily legible and non-erasable.		N.A.
10.4	A measuring instrument for direct sales trading transactions shall be designed to present the measurement result to both parties in the transaction when installed as intended. When critical in case of direct sales, any ticket provided to the consumer by an ancillary device not complying with the appropriate requirements of this Directive shall bear appropriate restrictive information.		N.A.
10.5	Whether or not a measuring instrument intended for utility measurement purposes can be remotely read it shall in any case be fitted with a metrologically controlled display accessible without tools to the consumer. The reading of this display is the measurement result that serves as the basis for the price to pay.		Pass
11	Further processing of data to conclude the trading transaction		Pass
11.1	A measuring instrument other than a utility measuring instrument shall record by a durable means the measurement result accompanied by information to identify the particular transaction, when: (a) the measurement is non-repeatable; and (b) the measuring instrument is normally intended for use in the absence of one of the trading parties.		Pass
11.2	Additionally, a durable proof of the measurement result and the information to identify the transaction shall be available on request at the time the measurement is concluded.		Pass
12	Conformity evaluation		
	A measuring instrument shall be designed so as to allow ready evaluation of its conformity with the appropriate requirements of this Directive.		Pass

Annex II, Module B: EU-Type Examination

1	'EU-type examination' is the part of a conformity assessment procedure in which a notified body examines the technical design of an instrument and verifies and attests that the technical design of the instrument meets the requirements of this Directive that apply to it.	Type exam. Cert.	Pass
2	EU-type examination may be carried out in either of the following manners: (a) examination of a specimen, representative of the production envisaged, of the complete measuring instrument (production type), (b) assessment of the adequacy of the technical design of the instrument through examination of the technical documentation and supporting evidence referred to in point 3, plus examination of	Option (a)	Pass

	specimens, representative of the production envisaged, of one or more critical parts of the instrument (combination of production type and design type); (c) assessment of the adequacy of the technical design of the instrument through examination of the technical documentation and supporting evidence referred to in point 3, without examination of a specimen (design type). The notified body decides on the appropriate manner and the specimens required.		
3	The manufacturer shall lodge an application for EU-type examination with a single notified body of his choice. The application shall include: (a) the name and address of the manufacturer and, if the application is lodged by the authorized representative, his name and address as well; (b) a written declaration that the same application has not been lodged with any other notified body; (c) the technical documentation as described in Article 18. The technical documentation shall make it possible to assess the instrument's conformity with the applicable requirements of this Directive and shall include an adequate analysis and assessment of the risk(s). The technical documentation shall specify the applicable requirements and cover, as far as relevant for the assessment, the design, manufacture and operation of the instrument. The application shall in addition contain, wherever applicable: (d) the specimens, representative of the production envisaged. The notified body may request further specimens if needed for carrying out the test programme; (e) the supporting evidence for the adequacy of the technical design solution. This supporting evidence shall mention any documents that have been used, in particular where the relevant harmonized standards, and/or normative documents have not been applied in full. The supporting evidence shall include, where necessary, the results of tests carried out in accordance with other relevant technical specifications by the appropriate laboratory of the manufacturer, or by another testing laboratory on his behalf and under his responsibility.		Pass
4	The notified body shall: For the instrument:		
4.1	examine the technical documentation and supporting evidence to assess the adequacy of the technical design of the instrument;		Pass
	The notified body shall: For the specimen(s):		
4.2	verify that the specimen(s) have been manufactured in conformity with the technical documentation and identify the elements which have been designed in accordance with the applicable provisions of the relevant harmonised standards and/or normative documents, as well as the elements which have been designed in accordance with other relevant technical specifications;		Pass
4.3	carry out appropriate examinations and tests, or have them carried out, to check whether, where the manufacturer has chosen to apply		Pass

	the solutions in the relevant harmonized standards and normative documents, these have been applied correctly;		
4.4	carry out appropriate examinations and tests, or have them carried out, to check whether, where the solutions in the relevant harmonized standards, and/or normative documents have not been applied, the solutions adopted by the manufacturer applying other relevant technical specifications meet the corresponding essential requirements of this Directive;		Pass
4.5	agree with the manufacturer on the location where the examinations and tests will be carried out.		Pass
	For the other parts of the measuring instrument:		
4.6	examine the technical documentation and supporting evidence to assess the adequacy of the technical design of the other parts of the measuring instrument.		Pass
5	The notified body shall draw up an evaluation report that records the activities undertaken in accordance with point 4 and their outcomes. Without prejudice to its obligations vis-à-vis, the notifying authorities, the notified body shall release the content of that report, in full or in part, only with the agreement of the manufacturer.	This document	Pass
6	<p>Where the type meets the requirements of this Directive, the notified body shall issue an EU-type examination certificate to the manufacturer. That certificate shall contain the name and address of the manufacturer, the conclusions of the examination, the conditions (if any) for its validity and the necessary data for identification of the approved type. The EU-type examination certificate may have one or more annexes attached.</p> <p>The EU-type examination certificate and its annexes shall contain all relevant information to allow the conformity of manufactured measuring instruments with the examined type to be evaluated and to allow for in-service control. In particular, to allow the conformity of manufactured instruments to be evaluated with the examined type regarding the reproducibility of their metrological performances, when they are properly adjusted using appropriate means, content shall include:</p> <ul style="list-style-type: none"> • the metrological characteristics of the type of instrument; • measures required for ensuring the integrity of the instruments (sealing, identification of software, etc.); • information on other elements necessary for the identification of the instruments and to check their visual external conformity to type; • if appropriate, any specific information necessary to verify the characteristics of manufactured instruments; • in the case of a sub-assembly, all necessary information to ensure the compatibility with other sub-assemblies or measuring instruments. <p>The EU-type examination certificate shall have a validity of 10 years from the date of its issue, and may be renewed for subsequent periods of 10 years each.</p> <p>Where the type does not satisfy the applicable requirements of this</p>		Pass

	Directive, the notified body shall refuse to issue an EU-type examination certificate and shall inform the applicant accordingly, giving detailed reasons for its refusal.		
7	The notified body shall keep itself apprised of any changes in the generally acknowledged state of the art which indicate that the approved type may no longer comply with the applicable requirements of this Directive, and shall determine whether such changes require further investigation. If so, the notified body shall inform the manufacturer accordingly.	KEMA Laboratories procedures	Pass
8	The manufacturer shall inform the notified body that holds the technical documentation relating to the EU-type examination certificate of all modifications to the approved type that may affect the conformity of the instrument with the essential requirements of this Directive or the conditions for validity of that certificate Such modifications shall require additional approval in the form of an addition to the original EU-type examination certificate.	Responsibility of manufacturer	
9	Each notified body shall inform its notifying authority concerning the EU-type examination certificates and/or any additions thereto which it has issued or withdrawn, and shall, periodically or upon request, make available to its notifying authority the list of such certificates and/or any additions thereto refused, suspended or otherwise restricted. The Commission, the Member States and the other notified bodies may, on request, obtain a copy of the EU-type examination certificates and/or additions thereto. On request, the Commission and the Member States may obtain a copy of the technical documentation and the results of the examinations carried out by the notified body. The notified body shall keep a copy of the EU-type examination certificate, its annexes and additions, as well as the technical file including the documentation submitted by the manufacturer until the expiry of the validity of that certificate.	KEMA Laboratories procedures	Pass
10	The manufacturer shall keep a copy of the EU-type examination certificate, its annexes and additions together with the technical documentation at the disposal of the national authorities for 10 years after the instrument has been placed on the market.		Pass

Annex V, Active Electrical Energy Meters (MI-003)

1	Accuracy The manufacturer shall specify the class index of the meter. The class indices are defined as: Class A, B and C.	See chapter 3	Pass
2	Rated operating conditions The manufacturer shall specify the rated operating conditions of the meter; in particular: The values of f_n , U_n , I_n , I_{st} , I_{min} , I_{tr} and I_{max} that apply to the meter. For the current values specified, the meter shall satisfy the conditions given in Table 1 (see MID)	See chapter 3	Pass
	The voltage, frequency and power factor ranges within which the meter shall satisfy the MPE requirements are specified in Table 2.		Pass

	<p>These ranges shall recognize the typical characteristics of electricity supplied by public distribution systems.</p> <p>The voltage and frequency ranges shall be at least:</p> $0,9 \cdot U_n \leq U \leq 1,1 \cdot U_n$ $0,98 \cdot f_n \leq f \leq 1,02 \cdot f_n$ <p>power factor range at least from $\cos\phi = 0,5$ inductive to $\cos\phi = 0,8$ capacitive.</p>		
3	<p>MPEs</p> <p>The effects of the various measurands and influence quantities (a, b, c,...) are evaluated separately, all other measurands and influence quantities being kept relatively constant at their reference values. The error of measurement, that shall not exceed the MPE stated in Table 2, is calculated as: Error of measurement = $\sqrt{(a^2+b^2+c^2 \dots)}$</p> <p>When the meter is operating under varying-load current, the percentage errors shall not exceed the limits given in Table 2.</p> <p>When a meter operates in different temperature ranges the relevant MPE values shall apply.</p> <p>The meter shall not exploit the MPEs or systematically favour any party.</p>	See chapter 5	Pass
4	Permissible effect of disturbances		
4.1	<p>General</p> <p>As electrical energy meters are directly connected to the mains supply and as mains current is also one of the measurands, a special electromagnetic environment is used for electricity meters. EN L 96/210 Official Journal of the European Union 29.3.2014</p> <p>The meter shall comply with the electromagnetic environment E2 and the additional requirements in points 4.2 and 4.3.</p> <p>The electromagnetic environment and permissible effects reflect the situation that there are disturbances of long duration which shall not affect the accuracy beyond the critical change values and transient disturbances, which may cause a temporary degradation or loss of function or performance but from which the meter shall recover and shall not affect the accuracy beyond the critical change values.</p> <p>When there is a foreseeable high risk due to lightning or where overhead supply networks are predominant, the metrological characteristics of the meter shall be protected.</p>	See chapter 4	Pass
4.2	<p>Effect of disturbances of long duration</p> <ul style="list-style-type: none"> Reversed phase sequence Voltage unbalance (only applicable to polyphase meters) Harmonic contents in the current circuits DC and harmonics in the current circuit Fast transient bursts Magnetic fields; HF (radiated RF) electromagnetic field; <p>Conducted disturbances introduced by radio-frequency fields; and Oscillatory waves immunity</p>	See chapter 4	Pass
4.3	Permissible effect of transient electromagnetic phenomena		
4.3.1	The effect of an electromagnetic disturbance on an electrical	See	Pass

	<p>energy meter shall be such that during and immediately after a disturbance:</p> <ul style="list-style-type: none"> any output intended for testing the accuracy of the meter does not produce pulses or signals corresponding to an energy of more than the critical change value, and in reasonable time after the disturbance the meter shall: recover to operate within the MPE limits, and have all measurement functions safeguarded, and allow recovery of all measurement data present prior to the disturbance, and not indicate a change in the registered energy of more than the critical change value. <p>The critical change value in kWh is $m \cdot U_n \cdot I_{max} \cdot 10^{-6}$ (m being the number of measuring elements of the meter, U_n in Volts and I_{max} in Amps).</p>	chapter 4	
4.3.2	For overcurrent the critical change value is 1,5 %.	See § 4.5	Pass
5	Suitability		
5.1	Below the rated operating voltage the positive error of the meter shall not exceed 10 %.		Pass
5.2	The display of the total energy shall have a sufficient number of digits to ensure that when the meter is operated for 4 000 hours at full load ($I = I_{max}$, $U = U_n$ and $PF = 1$) the indication does not return to its initial value and shall not be able to be reset during use.		Pass
5.3	In the event of loss of electricity in the circuit, the amounts of electrical energy measured shall remain available for reading during a period of at least 4 months.		Pass
5.4	Running with no load When the voltage is applied with no current flowing in the current circuit (current circuit shall be open circuit), the meter shall not register energy at any voltage between $0,8 \cdot U_n$ and $1,1 U_n$.	See § 4.3.4	Pass
5.5	Starting The meter shall start and continue to register at U_n , $PF = 1$ (polyphase meter with balanced loads) and a current which is equal to I_{st} .	See § 4.3.3	Pass
6	Units The electrical energy measured shall be displayed in kilowatt-hours or in megawatt-hours.	See § 4.1.9	Pass

Appendix E Measurement uncertainty

The measurement uncertainties in the results presented are as specified below unless otherwise indicated.

EMC Emission

Measurement	Measurement uncertainty	
	U_{lab}	U_{CISPR}
Conducted emission (CISPR 32)		
Mains port	2,84 dB	3,4 dB
TP communication ports	4,62 dB	5,0 dB